



Operating Instructions

Absorption Refrigerator for Recreation Vehicles

RM 8400 RM 8401 RM 8405 RM 8500 RM 8501 RM 8505 RM 8550 RM 8551 RM 8555
RMS 8400 RMS 8401 RMS 8405 RMS 8460 RMS 8461 RMS 8465 RMS 8500 RMS 8501
RMS 8505 RMS 8550 RMS 8551 RMS 8555 RML 8550 RML 8551 RML 8555 RMSL 8500
RMSL 8501 RMSL 8505



Type C40 / 110

Record for future reference:

Model number
Product number
Serial number

MBA 06/2010

N 5-1

English



Dometic GmbH
In der Steinwiese 16
D-57074 Siegen

www.dometic.com

Table of contents

1.0	General	4
1.1	Introduction	4
1.2	Guide to these operating instructions	4
1.3	Copyright protection	4
1.4	Explanation of symbols used in this manual	4
1.5	Warranty	5
1.6	Limitation of liability	5
1.7	Customer services	5
1.8	Spare parts	6
1.9	Environmental notices	6
1.10	Declaration of conformity	6
2.0	Safety instructions	7
2.1	Application according to regulations	7
2.2	User's responsibility	7
2.3	Protection of children when disposing of the equipment	7
2.4	Working upon and checking the refrigerator	7
2.5	Information on coolant	8
2.6	Operating the refrigerator with gas	8
2.7	Safety instructions when storing foodstuffs	9
3.0	Description of model	10
3.1	Model identification	10
3.2	Refrigerator rating plate	10
3.3	Technical data	11
3.4	Description of refrigerator	12
4.0	Refrigerator operation	13
4.1	Cleaning	13
4.2	Maintenance	13
4.3	Explanation of operating controls	14
4.3.1	Electrical operation	16
4.3.2	Gas operation	17
4.3.3	Setting of cooling compartment temperature	19
4.3.4	Additional features	19
4.4	Door locking	20
4.4.1	Mechanical door lock	20
4.4.2	Fastening and releasing the door lock hook when parking the vehicle	20
4.5	Lighting	21
4.6	Positioning the storage racks	21
4.7	Removable freezer compartment	21
4.8	Storing food and making ice cubes	22
4.8.1	Storing products in the cooling compartment	22
4.8.2	Storing products in the freezer compartment	22
4.8.3	Making ice cubes	22
4.9	Defrosting	23
4.10	Shutting off the refrigerator	23
4.11	Exchange of the igniter's battery	24
4.12	Winter operation	24
4.13	Changing the decor panel	25
4.14	Information on failure display and trouble-shooting	26
4.14.1	Status messages on the display	26
4.14.2	troubleshooting	27

1.0 General

1.1 Introduction

You have made an excellent choice in selecting the **Dometic** Absorption Refrigerator. We are sure that you will be satisfied with your new refrigerator in all respects. The refrigerator, which works silently, meets high quality standards and guarantees the efficient utilisation of resources and energy throughout its entire life cycle, during manufacture, in use and when being disposed of.

1.2 Guide to these operating instructions

Before you start using the refrigerator, please read the operating instructions carefully.

These instructions provide you with the necessary guidance for the proper use of your refrigerator. **Observe in particular the safety instructions.** Observation of the instructions and handling recommendations is important for dealing with the refrigerator safely and for protecting you from injury and the refrigerator from damage. You must understand what you have read before you carry out a task.

Keep these instructions in a safe place close to the refrigerator so they may be referred to at any time.

1.3 Copyright protection

The information, texts and illustrations in these instructions are copyright protected and are subject to industrial property rights.

No part of these instructions may be reproduced, copied or utilised in any other way without written authorisation by Dometic GmbH, Siegen.

1.4 Explanation of symbols used in this manual

Warning notices

Warning notices are identified by symbols. A supplementary text gives you an explanation of the degree of danger.

Observe these warning notices rigorously. You will thus protect yourself and other people from injury, and the appliance from damage.



DANGER!

DANGER indicates an imminent hazardous situation which, if not avoided, could result in death or serious injury.



WARNING!

WARNING indicates a potentially hazardous situation which, if not avoided, could result in death or serious injury



CAUTION!

CAUTION indicates a potentially hazardous situation which, if not avoided, may result in minor or moderate injury.

CAUTION!

CAUTION (used without the safety alert symbol) indicates a potentially hazardous situation which, if not avoided, may result in damage to the appliance.

Information



INFORMATION gives you supplementary and useful guidance when dealing with your refrigerator.

Environmental Tips



ENVIRONMENTAL TIPS gives you useful guidance for saving energy and disposal of the appliance.

1.5 Warranty

Warranty arrangements are in accordance with EC Directive 44/1999/CE and the normal conditions applicable for the country concerned. For warranty or other maintenance, please contact our customer services department. Any damage due to improper use is not covered by the warranty. The warranty does not cover any modifications to the appliance or the use of **non-original Dometic parts**. The warranty does not apply if the installation and operating instructions are not adhered to and no liability shall be entertained.

1.6 Limitation of liability

All information and guidance in these operating instructions were prepared after taking into consideration the applicable standards and regulations as well as the current state of the art. **Dometic** reserves the right to make changes at any time which are deemed to be in the interest of improving the product and safety.

Dometic will assume no liability for damage in the case of :

- non-observation of the operating instructions
- application not in accordance with the regulations or provisions
- use of non-original spare parts
- improper modifications and interferences to the appliance
- effect of environmental influences, such as
 - temperature fluctuations
 - humidity

1.7 Customer services

Dometic offers a pan-European customer service network. Find your authorised customer service centre by calling the phone number indicated in the EuroService Network book, **EuroService Network** - which accompanies every refrigerator. You can also obtain the address information of the nearest customer service from **www.dometic.com**. When contacting Dometic Customer Services, please state the model, product number and serial number together with the MLC code, if applicable. You will find this information on the rating plate inside the refrigerator. We recommend that you note this data in the field provided on the front page of this operation manual.

1.8 Spare parts

Parts can be ordered throughout Europe from our customer services.

Always give the model and product number when you contact the customer service! You will find this information on the rating plate inside the refrigerator.

1.9 Environmental notices



Refrigerators manufactured by Dometic GmbH are free of CFC/HCFC and HFC. Ammonia (a natural compound of hydrogen and nitrogen) is used in the cooling unit as a coolant. Non-ozone-hazardous cyclopentane is used as a propellant for manufacturing PU foam insulation.

Disposal

In order to ensure that the recyclable packaging materials are re-used, they should be sent to the customary local collection system. The appliance should be transferred to a suitable waste disposal company that will ensure re-use of the recyclable components and proper disposal of the rest. For eco-friendly draining of the coolant from all absorber refrigeration units, a suitable disposal plant should be used.

Energy-saving tips

- At an average ambient temperature of 25°C, it is sufficient to operate the refrigerator at middle thermostat setting.
- Where possible, always store precooled products.
- Do not expose the refrigerator to direct sunlight.
- Ensure that air circulation of the cooling unit is not obstructed.
- Defrosting at regular intervals saves energy (see section 4.8 "Defrosting").
- Open the refrigerator door only for a short period of time when removing products.
- Run the refrigerator for about 12 hours before filling it.

1.10 Declaration of conformity

DECLARATION OF CONFORMITY	
according to	
Low Voltage Directive 73/23/EEC and the Amendment to LVD 2006/95/EC EMC Directive 2004/108/EC Automotive Directive 72/245/EEC and the Amendment 95/54/EC, 2006/28/EC Gas Appliance Directive 2009/142/EC End-of-Life Vehicle Directive 2000/53/EC RoHS Directive 2002/95/EC	
Type of equipment Brand Name Type family Manufacturer's (Factory) name address telephone no telefax no	Absorption Refrigerator DOMETIC C 40/110 DOMETIC GmbH In der Steinwiese 16, D-57074 Siegen INT+49 - 271 692 0 INT+49 - 271 692 304
The following harmonized standards or technical specifications (designations) which comply with good engineering practice in safety matters in force within the EEA have been practiced:	
EN 60335-1;02, (IEC 60335-1; 4 ed., Am. 1, Am. 2), EN 60335-2-24;03 (IEC 60335-2-24; 6 ed., Am. 1) EN 61000-3-2;00, A1, A2, A14 EN 61000-3-3;95, A1, EN 55014-1;07, A1, A2 EN 55014-2;01, A1 EN 732;98 EN 60335-2-102;06 EN 624;00 (LSC-Models) EN 30 -1-1;08 (Tectower-Models) EN 30-2-1; 98 A1, A2 (Tectower-Models)	
The equipment conforms completely with the above stated harmonized standards or technical specifications.	
By signing this document, the undersigned declares as manufacturer, or the manufacturer's authorized representative established within the EEA, that the equipment in question complies with the requirements stated above.	
Date 2010.06.07	Signature Dr. Michael Freitag
	Position General Manager

2.0 Safety instructions

2.1 Application according to regulations

This refrigerator is designed for installation in recreation vehicles such as caravans or motorhomes. The appliance has been type-approval tested for this application in accordance with the EC Gas Directive.

The refrigerator is to be used solely for storing foodstuffs.

**WARNING!**

The refrigerator is not suitable for the proper storage of medication. Please observe in addition the instructions in the medication package inserts.

2.2 User's responsibility

Anyone operating the refrigerator must be familiar with the safe handling and understand the advice in these operating instructions.

This appliance is not intended for use by persons (including children) with reduced physical, sensory or mental capabilities, or lack of experience and knowledge, unless they are supervised or have been given instruction concerning use of the appliance by a person responsible for their safety. Children should be supervised to ensure that they do not play with the appliance. Cleaning and user maintenance shall not be made by children.

[EN 60335-2-24, 7.12]

2.3 Protection of children when disposing of the equipment

**WARNING!**

When disposing of the refrigerator, detach all refrigerator doors and leave the storage racks in the refrigerator. In this way inadvertent entrapment and suffocation is prevented.

2.4 Working upon and checking the refrigerator

**WARNING!**

Work on gas equipment, exhaust system and electrical facilities must be carried out by authorised personnel only. Substantial damage to property and/or injury to persons can arise through unprofessional procedures.

**DANGER!**

Never use an unshielded flame to check gas bearing parts and pipes for leakage!

There is a danger of fire or explosion.

**WARNING!**

Never open the absorber cooling unit! It is under high pressure.

There is a danger of injury!

2.5 Information on coolant

Ammonia is used as a coolant.

This is a natural compound also used in household cleaning agents (1 litre of Salmiak cleaner contains up to 200g of ammonia - about twice as much as is used in the refrigerator). Sodium chromate is used for corrosion protection (1.8% by weight of the solvent).

In the event of leakage (easily identifiable from the strong odour), proceed as follows:

- Switch off the appliance.
- Air the room thoroughly.
- Inform authorised customer services.



For your safety it was ascertained in an expert's report that no impairment of health exists when the coolant is discharged.

2.6 Operating the refrigerator with gas

It is imperative that the operating pressure corresponds to the data specified on the rating plate of the appliance. Compare the operating pressure of the rating plate with the data specified on the pressure reducing valve of the liquid gas cylinder.



WARNING!

Operating the appliance with gas is not permitted

- at petrol stations
- on ferry boats
- while transporting the caravan/motor-home by a transporter or breakdown vehicle.

There is the danger of fire!

Leave the equipment switched off.

2.7 Safety instructions when storing foodstuffs

Instructions for storing food in a refrigerator:

No refrigerator of any kind can improve the quality of the food; refrigerators can only maintain the food's quality for a short duration as from the time of storing it.

Please observe the following particular conditions for storing food in a refrigerator that is built into a vehicle:

- A change in the climatic conditions such as temperature fluctuations
- High temperatures inside the vehicle when it is closed and parked in direct sunlight (temperatures are possible up to 50°C)
- Use of the refrigerator during travel with the power supply of 12V DC
- A refrigerator built in behind a window and exposed to direct sunlight
- Storing the products too soon, i.e. shortly after starting up the appliance for use

Under these particular conditions the refrigerator cannot guarantee reaching the temperature needed for perishables.

Perishables include all products with a stipulated use-by date and a minimum storage temperature of +4°C or less, especially for meat, poultry, fish, sausages, pre-packed foods.

- Pack raw and cooked foods separately (e.g. in containers, aluminium foil, etc.).
- Only remove the outside packaging of single packs if all the necessary information, e.g. the use-by date, can also be read on the single packs.
- Do not leave cooled goods outside the refrigerator for too long.
- Place the foods with the next use-by date at the front, accordingly.
- Pack away any left-over food and eat at the first opportunity.
- Wash your hands before and after handling any food.

- Regularly clean the inside of the refrigerator.

Please observe the instructions and information regarding the use-by date on the outside packaging of the food.

Please observe section "4.1 Cleaning" of this instruction.

3.0 Description of model

3.1 Model identification

Example :

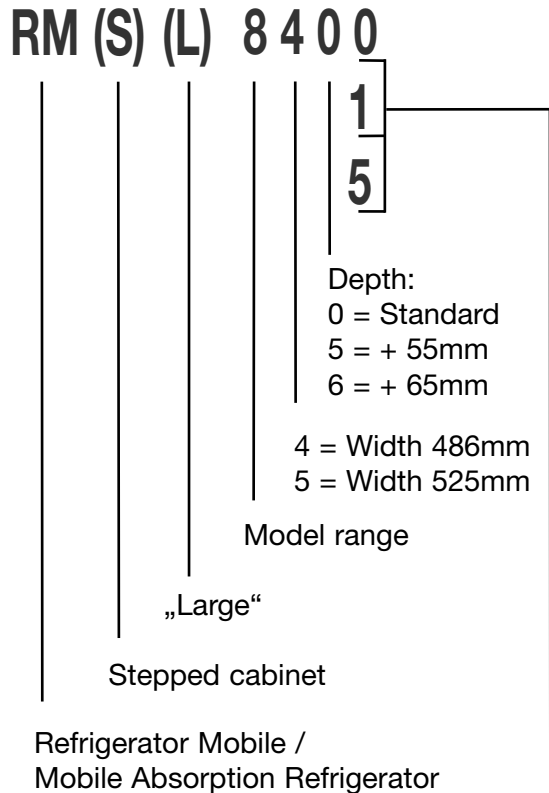

0 = manual energy selection + manual ignition (**battery igniter**)

1 = manual energy selection, automatic ignition (**MES**)

5 = automatic and manual energy selection, automatic ignition (**AES**)

3.2 Refrigerator rating plate

The rating plate is to be found on the inside of the refrigerator. It contains all important details of the refrigerator. You can read off from this the model identification, the product number and the serial number. You will need these details whenever you contact the customer service centre or when ordering spare parts.

Dometic			
TYPE	C 40/110	CLIMATE CLASS	SN
MOD. NO.	RMS 8400 1	PROD. NO.	00921084272 2 C DD
SER. NO.	99900165 3		
BRUTTOINHALT TOTAL CAP. VOLUME BRUT	80 l 85 l	VERDAMPFERFACH FREEZER COMP. VOLUME COMPT BT	8 l 0 l
NUTZINHALT USEFUL CAP. VOLUME NET	77 l 82 l		
~ 230 - 240V / 125 W 12 V / 120 W	LPG	Qn: 0,252 kW (H8) ñ: 18,3 g/h	
4	5	13 + 28 - 30/37 13B/P 28 - 30 13P 37	mbar
CE 0063 BL3214	G30, G31	p = 30/37 mbar	
ABSORPTION	NH ₃ = 115 g	Na ₂ CrO ₄ = 7,0 g	p max = 35 bar
07	0085	021654	2.660
FKW, FCKW FREI / CFC, HCFC FREE	MADE IN GERMANY	00057364562	

Fig. 1

- 1** Model number
- 2** Product number
- 3** Serial number
- 4** Electrical rating details
- 5** Gas pressure



Dometic refrigerators are equipped for a connection pressure of **30 mbar**. For connection to a 50 mbar gas system, use **Truma VDR 50/30 medium pressure controller**.

3.3 Technical data

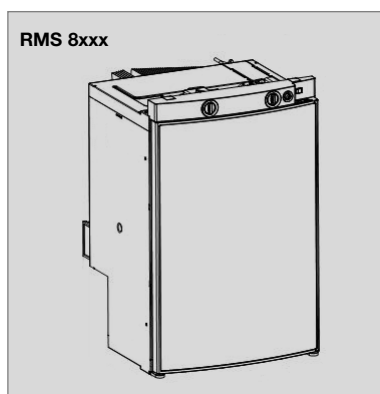

Fig. 2

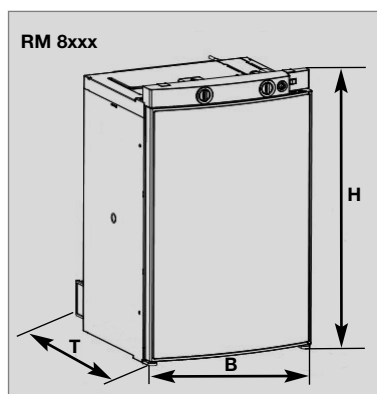

Fig. 3



Fig. 4

Model	Dimensions H x W x D (mm) Depth incl. door	Gross capacity		Rating details mains/battery	Consumption * electricity/gas over 24hrs	Net weight	Ignition	
		with freezer compartment	without freezer compartment				Piezo	Automat
RMS 8400	821x486x568	80 / 8 lit.	85 lit.	125 W / 120 W	ca.2,5 KWh / 270 g	25 kg	•	
RMS 8401	821x486x568	80 / 8 lit.	85 lit.	125 W / 120 W	ca.2,5 KWh / 270 g	25 kg		•
RMS 8405	821x486x568	80 / 8 lit.	85 lit.	125 W / 120 W	ca.2,5 KWh / 270 g	25 kg		•
RM 8400	821x486x568	90 / 8 lit.	95 lit.	135 W / 130 W	ca.2,4 KWh / 270 g	27 kg	•	
RM 8401	821x486x568	90 / 8 lit.	95 lit.	135 W / 130 W	ca.2,4 KWh / 270 g	27 kg		•
RM 8405	821x486x568	90 / 8 lit.	95 lit.	135 W / 130 W	ca.2,4 KWh / 270 g	27 kg		•
RMS 8460	821x486x633	90 / 11 lit.	96 lit.	125 W / 120 W	ca.2,5 KWh / 270 g	26 kg	•	
RMS 8461	821x486x633	90 / 11 lit.	96 lit.	125 W / 120 W	ca.2,5 KWh / 270 g	26 kg		•
RMS 8465	821x486x633	90 / 11 lit.	96 lit.	125 W / 120 W	ca.2,5 KWh / 270 g	26 kg		•
RMS 8500	821x523x568	90 / 9 lit.	96 lit.	125 W / 120 W	ca.2,5 KWh / 270 g	26 kg	•	
RMS 8501	821x523x568	90 / 9 lit.	96 lit.	125 W / 120 W	ca.2,5 KWh / 270 g	26 kg		•
RMS 8505	821x523x568	90 / 9 lit.	96 lit.	125 W / 120 W	ca.2,5 KWh / 270 g	26 kg		•
RMS 8550	821x523x623	103 /12 lit.	110 lit.	125 W / 120 W	ca.2,6 KWh / 270 g	27 kg	•	
RMS 8551	821x523x623	103 /12 lit.	110 lit.	125 W / 120 W	ca.2,6 KWh / 270 g	27 kg		•
RMS 8555	821x523x623	103 /12 lit.	110 lit.	125 W / 120 W	ca.2,6 KWh / 270 g	27 kg		•
RM 8500	821x523x568	100 / 9 lit.	106 lit.	135 W / 130 W	ca.2,4 KWh / 270 g	28 kg	•	
RM 8501	821x523x568	100 / 9 lit.	106 lit.	135 W / 130 W	ca.2,4 KWh / 270 g	28 kg		•
RM 8505	821x523x568	100 / 9 lit.	106 lit.	135 W / 130 W	ca.2,4 KWh / 270 g	28 kg		•
RM 8550	821x523x623	115 /12 lit.	122 lit.	135 W / 130 W	ca.2,6 KWh / 270 g	30 kg	•	
RM 8551	821x523x623	115 /12 lit.	122 lit.	135 W / 130 W	ca.2,6 KWh / 270 g	30 kg		•
RM 8555	821x523x623	115 /12 lit.	122 lit.	135 W / 130 W	ca.2,6 KWh / 270 g	30 kg		•
RML 8550	1245x525x625	179 /33 lit.	189 lit.	190 W / 170 W	ca.3,2 KWh / 380 g	45 kg	•	
RML 8551	1245x525x625	179 /33 lit.	189 lit.	190 W / 170 W	ca.3,2 KWh / 380 g	45 kg		•
RML 8555	1245x525x625	179 /33 lit.	189 lit.	190 W / 170 W	ca.3,2 KWh / 380 g	45 kg		•
RMSL 8550	1245x525x625	145 /28 lit.	155 lit.	190 W / 170 W	ca.3,2 KWh / 380 g	40 kg	•	
RMSL 8551	1245x525x625	145 /28 lit.	155 lit.	190 W / 170 W	ca.3,2 KWh / 380 g	40 kg		•
RMSL 8555	1245x525x625	145 /28 lit.	155 lit.	190 W / 170 W	ca.3,2 KWh / 380 g	40 kg		•

Subject to technical changes.

*Average consumption measured at an average ambient temperature of 25°C in pursuance of ISO Standard.

3.4 Description of refrigerator

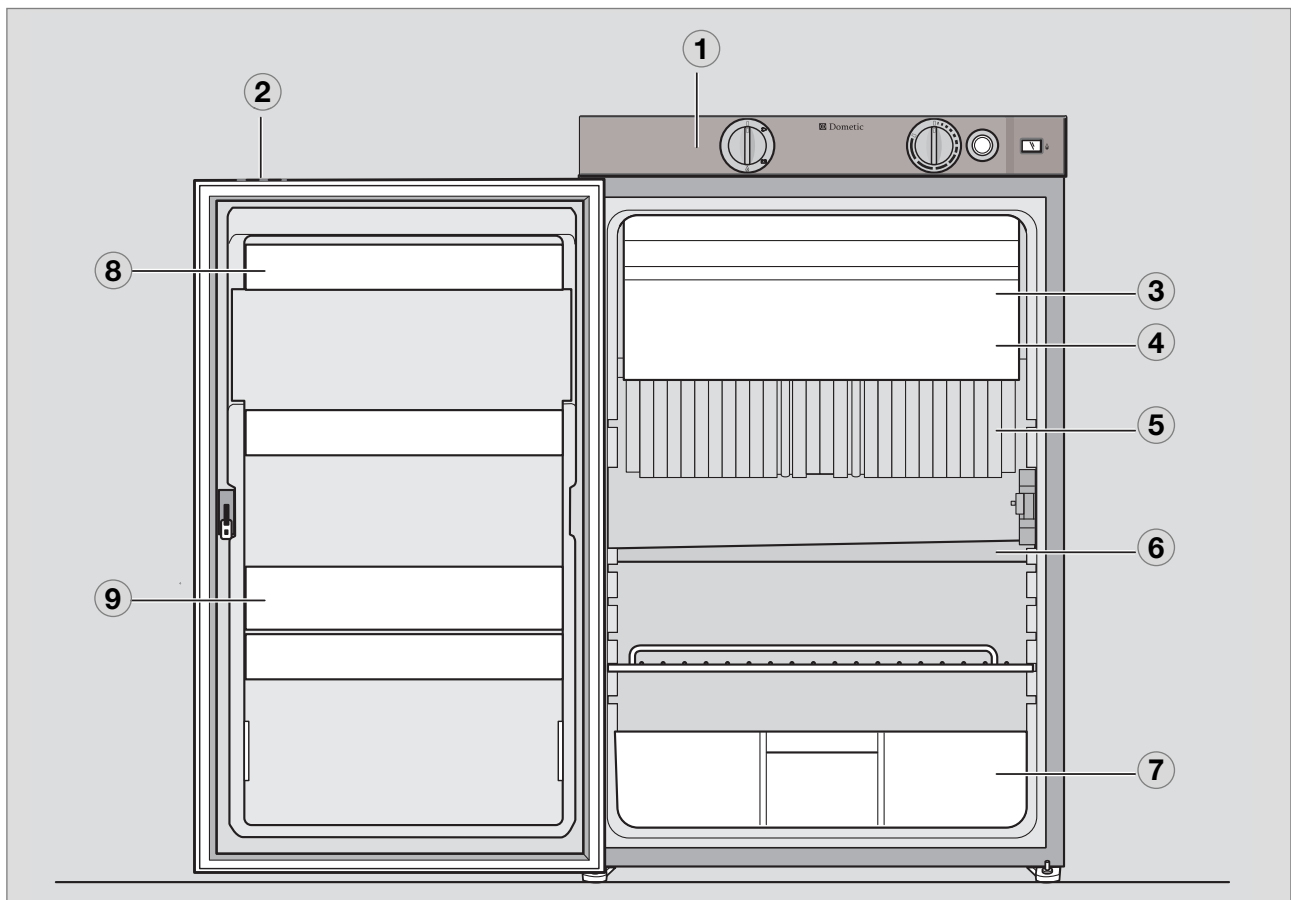

Fig. 5

- ① Operating controls
- ② Door locking button
- ③ Freezer compartment (removable)
- ④ Insertable grid shelf (available as option, to be used when freezer compartment is removed)
- ⑤ Post-evaporator for cooling compartment
- ⑥ Condensation water drain channel
- ⑦ Vegetable bin
- ⑧ Upper door shelf with flap, egg shelf available as option may be inserted
- ⑨ Lower door shelf with bottle holders

4.0 Refrigerator operation



The refrigerator is equipped to operate on three power modes:

- **Mains voltage (230V AC)**
- **Direct-current voltage (12V DC)**
- **Gas (liquid gas propane/butane)**

Select the desired power mode by the **energy selector switch** (battery igniter type models) or the **MODE button** (MES, AES). Appliances with automatic energy selection (AES) are additionally provided with "automatic mode" function. The AES system automatically selects the best energy source for each particular situation.

4.1 Cleaning

Before starting up the refrigerator, it is recommended that you clean it inside and repeat this at regular intervals.

Use a soft cloth and lukewarm water with a mild detergent. Then wipe out the appliance with clean water and dry thoroughly.

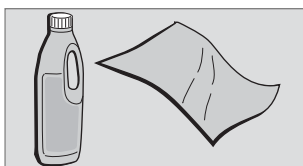

Fig. 6

To avoid material alterations, do not use soap or hard, abrasive or soda-based cleaning agents. Do not allow the door seal to come into contact with oil or grease.

4.2 Maintenance

- In compliance with the applicable regulations, please note that the gas unit and the connected ventilation ducts must be checked by authorised technical personnel after first use and after every other year for compliance with the European Standard EN 1949. A test certificate has to be issued. **It is the user's responsibility to arrange this test.**

- **The gas burner must be inspected and cleaned as necessary at least once a year. When using liquefied petroleum gas (tank or refill cylinders) the maintenance interval is reduced to half-yearly or quarterly.**

Keep the evidence of maintenance work carried out on your refrigerator.

- **Work on gas and electrical equipment shall be carried out by qualified personnel only.**

It is recommended that this is carried out by an authorised customer services department.

We recommend maintenance following an extended shutdown of the vehicle. Please contact our customer services.

4.3 Explanation of operating controls

Manual energy selection / manual ignition (RM 8xx0) battery igniter:

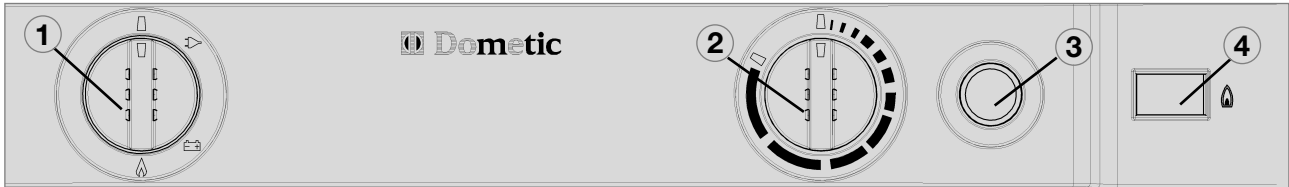

Fig. 8

- 1 = Power On switch / Energy selector switch
- 2 = Temperature controller
- 3 = Battery igniter (gas)
- 4 = Flame indicator (galvanometer)

Explanations:

The refrigerator is equipped to operate on mains power, 12V DC or liquid gas. Select the desired power supply by turning the energy selector switch "1". The energy selector switch "1" has four settings:

- Off
- Mains voltage (230V AC)
- Direct-current voltage (Batterie, 12V DC)
- Gas (liquid gas propane/butane)

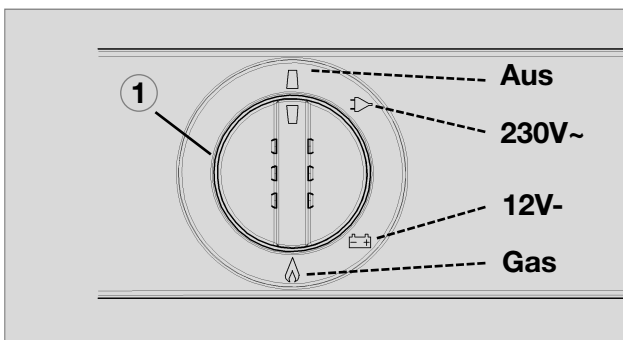

Fig. 9

Manual energy selection / automatic ignition (RM 8xx1) MES:

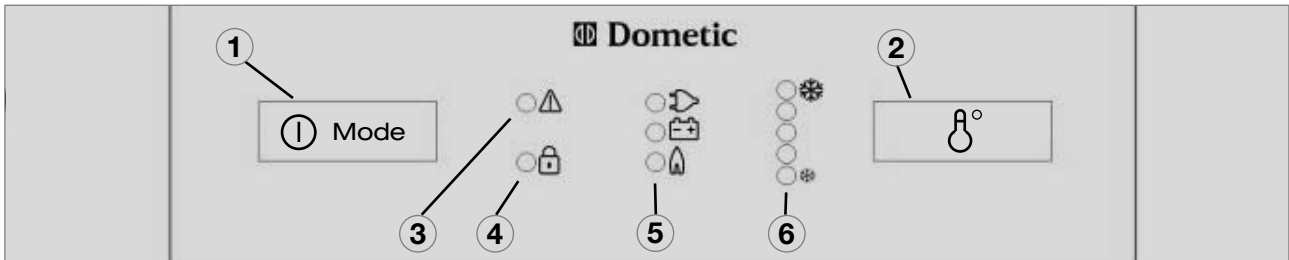

Fig. 9

Automatic energy selection / automatic ignition (RM 8xx5) AES:



Fig. 10

- ① = Power On switch / Energy selector switch (**MODE**)
- ② = Temperature selection
- ③ = Indicator LED failure
- ④ = Indicator LED door lock (optional)
- ⑤ = Indicator-LED / operating mode display
- ⑥ = Temperature level display

Explanations:

Switch the refrigerator **ON** or **OFF** by pressing button "1" for **3 seconds**.

Button "1" allows you to either initiate the requested energy supply or activate dimming of the LED brightness. By pushing once, the indicators illuminate for 10 seconds.

Button "3" and indicator "5" constitute an optional feature available with refrigerators equipped with electrical door locking (see also section 5.3 Door lock).

4.3.1 Electrical operation

Appliances with battery igniter (manual energy selection)

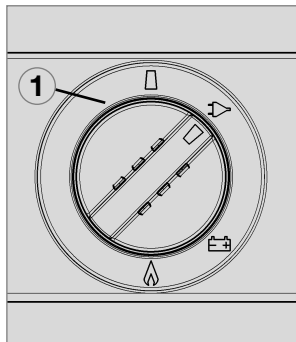

Fig. 11

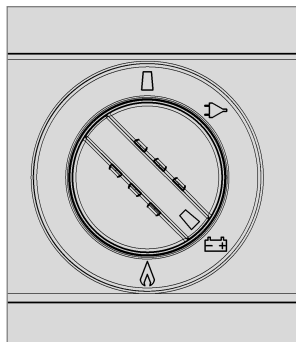
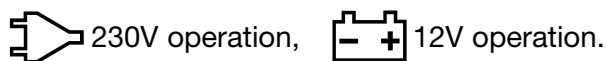

Fig. 12

Switch on the appliance by turning the energy selection switch "1" clockwise to position :



CAUTION !

The refrigerator should only be used in 12VDC-operation while the vehicle's engine is running, otherwise the on-board-battery would be discharged within a few hours!

MES Appliances (manual energy selection)

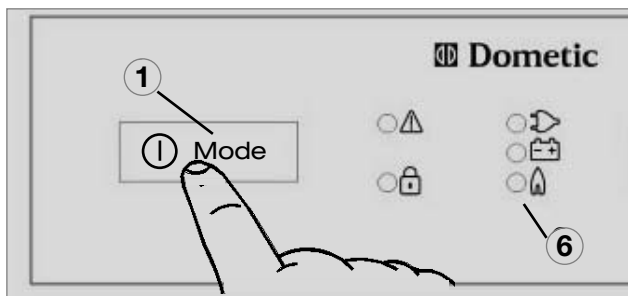
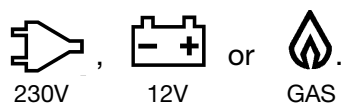

Fig. 13

To start the refrigerator, press button "1" for **3 seconds**.

The **LED "6"** of the previously selected operating mode illuminates:



Change the operating mode by pressing button "1" again. The appropriate indicator LED will illuminate.

AES Appliances (automatic energy selection)

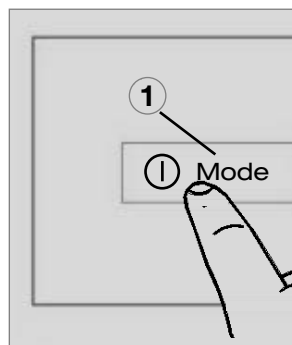

Fig. 15



Fig. 16

To start the refrigerator, press button "1" for **3 seconds**.

The previously selected operating mode is displayed, e.g. **230** which means 230V .

By pressing button "1" again, you may change the operating modes to:

- **AES** (automatic energy selection)
- **230V,12V, GAS** (manual energy selection)

Upon switching on, the electronics **automatically** selects one of the three possible energy types: **230V - 12V - liquid gas**. The control electronics automatically ensures that the refrigerator is supplied with the optimum source of energy in each respective case.

- Sequence of priority:**
- 1.) Solar (12V -)
 - 2.) 230V ~
 - 3.) 12V -
 - 4.) Liquid gas



If sufficient mains voltage is available (more than 195 V), this power source is selected as prime option. If a solar system capable of powering the refrigerator is installed, the solar 12V supply takes priority.

The 12V operation is otherwise only effective while the engine is running. The appliance electronic system features a low-voltage mechanism. Once the voltage drops below 10.5V, the appliance shuts down (manual mode) or switches over to a different energy source (AES mode).

4.3.2 Gas operation (Liquid gas)

- The refrigerator must be operated using liquid gas (**propane, butane**) (**no natural gas or town gas**). When using LPG gas, please consider that the burner needs cleaning at shorter intervals due to the gas combustion method (2 - 3 times per year recommended)
- In Europe, gas operation is permitted while travelling only on the condition that the gas system of the vehicle is equipped with a hose rupture protection. The national regulations of the respective country must be observed.
- For physical reasons, gas ignition faults could occur starting from an altitude above sea level of approx. 3280 ft. / 1000 m (**No malfunction!**)
- On the initial refrigerator start-up or after a cylinder change, air may be trapped in the gas line. To purge the air from the lines, switch on the refrigerator and any other gas appliances (e.g. stove) for a short time. The gas ignites without delay.



WARNING!

As a basic rule, gas operation is prohibited in petrol stations

Prior to starting the refrigerator in gas mode :

- Open the gas cylinder valve.
- Open the shut-off valve for gas supply to the refrigerator.

Appliances with battery igniter

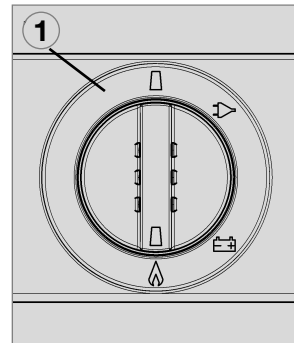

Fig. 17

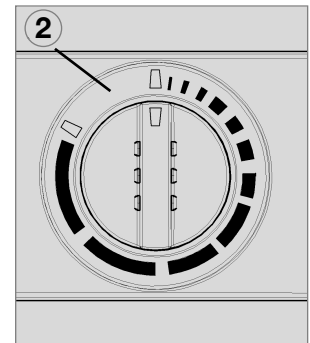



Fig. 18

1. Turn the rotary selector switch "1" to position  .
2. Turn the temperature selector "2" clockwise and push. Keep the controller button depressed.

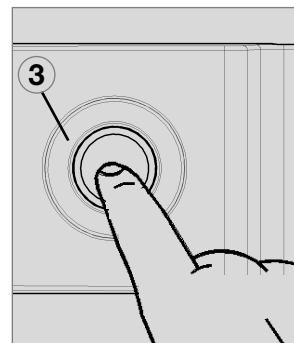

Fig. 19

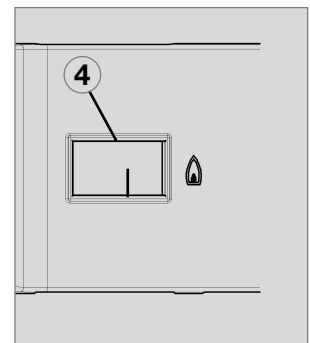

Fig. 20

3. Then, press knob "3" of battery igniter down and keep it depressed. The ignition process is activated automatically.
4. Once the flame ignites, the pointer of galvanometer "4" begins moving into the green range. The refrigerator is operational. Keep knob "2" depressed for approx. 15 seconds and finally release it.



Each refrigerator with manual ignition is equipped with an automatic flame safety valve which interrupts the gas supply automatically after approx. 30 seconds when the flame has extinguished.

MES Appliances

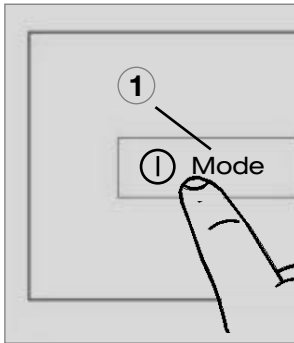

Fig. 21

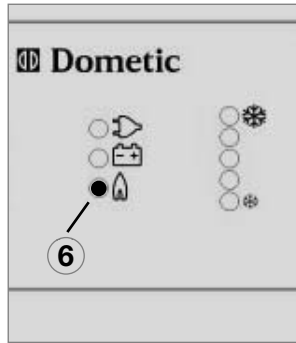



Fig. 22

1. Press button "1" several times until the indicator LED "6"  illuminates.
2. The ignition process is activated automatically by means of an automatic igniter.



The ignition system will make 2 ignition attempts with 25 seconds interval when the burner fails to light. If repeated attempts fail to start the operation, a fault is indicated (*please refer to failure indication*).

AES Appliances

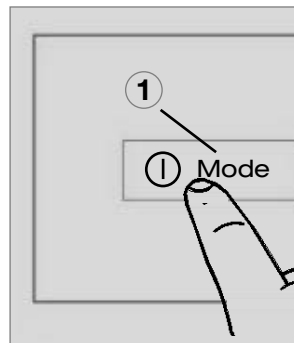

Fig. 23

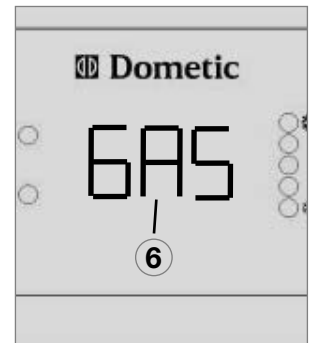

Fig. 24

Press button "1" several times until the indicator LED "6" **GAS** illuminates.

The device is now in manual gas mode. When you select the automatic mode (the display shows **AES**), **GAS** is only selected as energy option according to the sequence of priority when none of the two electrical types of power supply is available.

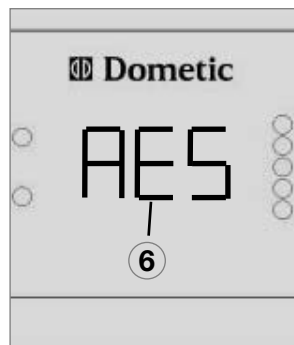

Fig. 25

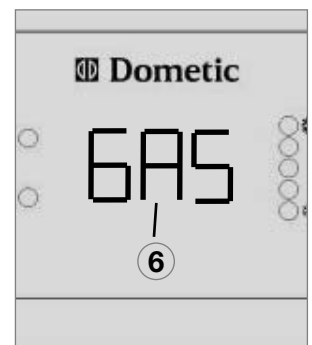

Fig. 26

In automatic mode, **AES** and the currently used type of power supply (e.g. **GAS**) are indicated alternately.

Switching over to a manual energy selection is possible at any time.

Refuelling while in AES mode operation



In order to prevent unintended switching to gas operation during refuelling, the electronic system starts gas operation of the refrigerator after the motor has been turned off for 15 minutes. During this period the appliance is ready for operation ("stand-by"). In automatic mode the "AES" indication only is illuminated.



WARNING!

The use of unshielded flames is prohibited in petrol station environments.

Should the refuelling stop last longer than 15 minutes, the refrigerator has to be switched off or switched over to another energy type.

4.3.3 Setting of cooling compartment temperature

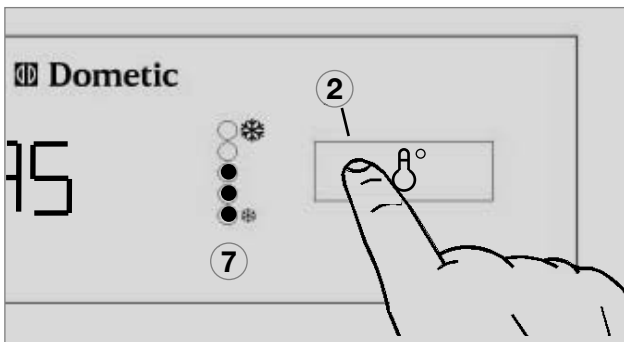

Fig. 26

Select the desired cooling compartment temperature by pressing button "2".

The LED display "7" of the selected temperature setting is illuminated.

The scale starts with **MIN** position at the bottom LED position (small crystal = highest temperature) and climbs up to **MAX** position at the upper LED position (large crystal = lowest temperature). Note: The temperature levels do not relate to absolute temperature values.



The cooling unit's performance is influenced by ambient temperatures. Please select the medium setting for ambient temperatures between +15°C and +25°C (refer to Fig. 28, temperature level 3). The unit operates within its optimum performance range.

Dometic refrigerators work according to the absorption principle. For physical reasons, an absorption system responds slowly to changes made by the thermostat controller, by loss of cooling energy through opening the door or during storing food. The devices meet the cooling performance requirements of the Climatic Class SN acc. to EN/ISO 7371 in the temperature range of +10°C to +32°C ambient temperature.

For temperatures below +10°C, winter covers should be installed. For ambient temperatures exceeding +32°C for a longer period of time, it is recommended installing Dometic additional fan (item no. 241 2985 - 00).

4.3.4 Additional features (MES and AES)

- The brightness of the display reduces after a few seconds if no other buttons are pressed.
- If the door is open, the interior lighting is switched off automatically after 2 minutes.
- Failures are indicated by flashing of the failure indicator LED.
- **AES-Models** : Should the door be kept open for too long (more than 2 minutes), an acoustic signal is initiated (pulsing whistle tone).
- **AES-Models** : Should the electronic control detect any failure, an acoustic signal will sound (pulsing whistle tone). At the same time the display starts flashing (for troubleshooting, please refer to *section 4.12*).

4.4 Door locking



CAUTION!

As a basic rule, shut and lock the refrigerator before you start your journey!

4.4.1 Mechanical door lock



Fig. 27

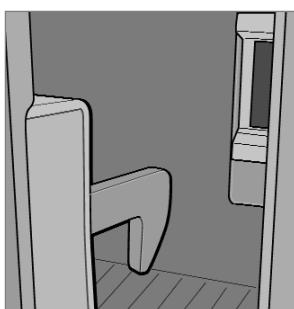

Fig. 28

Open the door by pressing the locking button and pull open (see Fig. 28).

Shut the door again by pushing it to close. The snapping into the lock can be heard.

While the vehicle is parked, the locking hook may be fixed to facilitate opening of the door (Fig. 29-32).

4.4.2 Fastening and releasing the door lock hook when parking the vehicle

If the vehicle is parked for a longer period of time, the locking hook may be clamped by means of a lockbar. The door may now be opened by just pulling it without need of pressing the locking button.

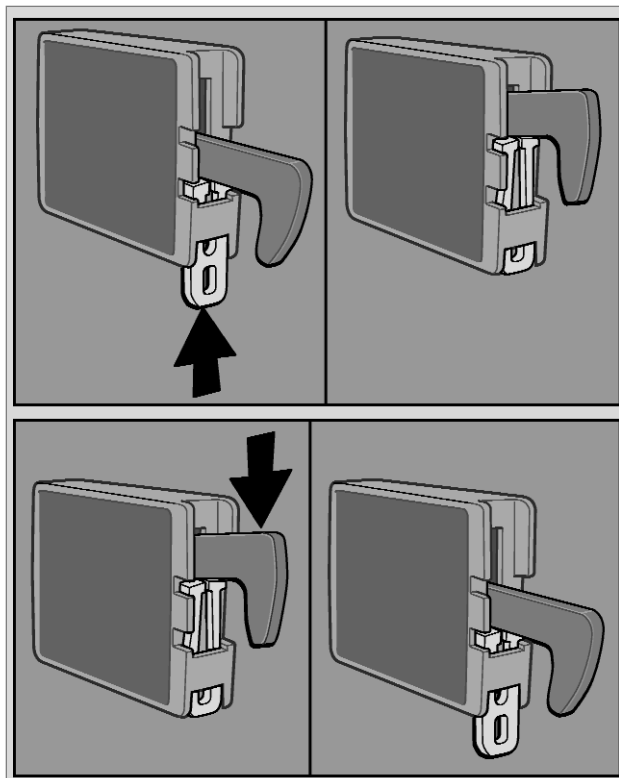

Fig. 29-32

4.5 Lighting

If the door is open for more than 2 minutes, the sensor-controlled interior lighting is automatically cut off (**except for models with battery igniter**).

AES-Models : Should the door be kept open more than 2 minutes, an acoustic signal is initiated (pulsing whistle tone).

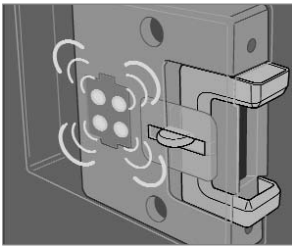

Fig. 33



Please contact the authorized Dometic Service if a failure occurs.

4.6 Positioning the storage racks

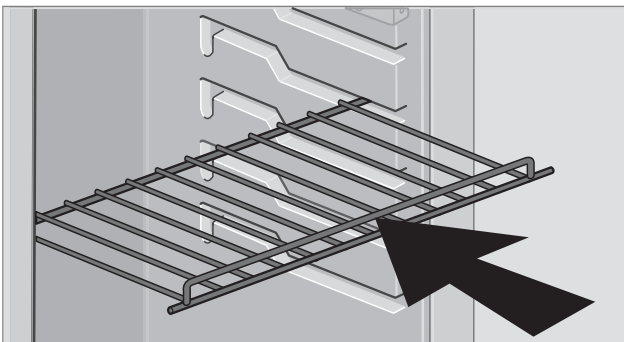

Fig. 34

The storage racks may be pulled out by smoothly lifting them and may be positioned as desired.

4.7 Removable freezer compartment

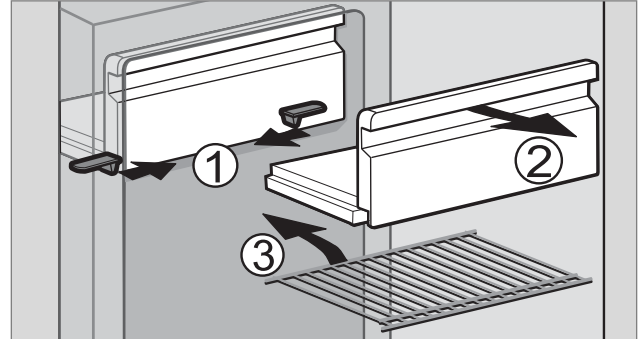

Fig. 35

To enlarge the cooling compartment, just remove the freezer compartment.

1. Unlock the freezer compartment on both sides.
2. Pull the freezer compartment out.

Store the freezer compartment safely in order to prevent damage



Once the freezer compartment is removed, an additional storage rack (3.) may be installed. The storage rack is a piece of extra equipment and may be obtained by **Dometic**.

4.8 Storing food and making ice cubes

4.8.1 Storing products in the cooling compartment

- Switch the refrigerator on approx. 12 hours before filling it.
- Always store pre-cooled foods in the refrigerator. Make sure that the food is well cooled when it is bought and also when transporting it. Use insulated cooling bags.
- Open the refrigerator door only for a short period of time when removing products.
- Products must be packed - best of all in closed containers, wrapped in aluminium foil or similar - and stored separately from each other, in order to prevent drying out or odours.
- Allow foods that have been warmed up to cool down before storing.
- Avoid storing products in the refrigerator that could emit volatile flammable gases.
- Do not expose the refrigerator to direct sunlight. Please bear in mind that the temperature inside a closed vehicle increases sharply if exposed to sunlight and that this can reduce the efficiency of the refrigerator.
- Ensure that air circulation of the cooling unit is not obstructed. Keep the ventilation grilles free from obstructions.

4.8.2 Storing products in the freezer compartment

- Do not keep carbonated drinks in the freezer.
- The freezer compartment is suitable for making ice cubes and for short-term storage of frozen food. It is not suitable as a means of freezing foods.#

When ambient temperatures are lower than +10°C and the refrigerator is exposed to these temperatures for extended periods of time, an even regulation of freezer temperature cannot be guaranteed for system-related reasons. This can cause the temperature in the freezer to rise and the stored goods to melt.

4.7.3 Making ice cubes

Ice cubes are best frozen overnight. At night, the refrigerator has less work to do and the unit has more reserves.

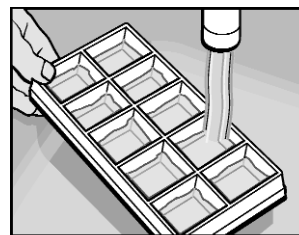

Fig. 36

1. Fill the ice cube tray with drinking water.

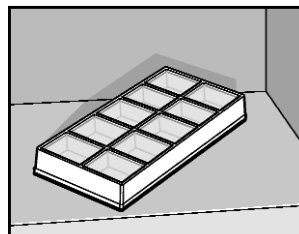

Fig. 37

2. Place the ice cube tray in the freezer compartment.



WARNING!

Only use drinking water!

4.9 Defrosting

As time goes by, frost builds up on the fins inside the refrigerator. A layer of frost thicker on one side may occur and does not represent a malfunction. When this layer of frost is about 3 mm thick, the refrigerator should be defrosted.

- Switch off the refrigerator, as described in section 4.9 *Shutting off the refrigerator*.
- Remove all food and the ice cube tray.
- Leave the refrigerator door open to allow air to enter and to prevent formation of mildew.
- After defrosting (freezer compartment and fins free of frost), wipe both cooling compartments dry with a cloth.

Note: Water thawing in the main compartment of the refrigerator runs into an appropriate container at the back of the refrigerator. From there, the water evaporates.

CAUTION!

The layer of ice must never be removed forcibly, nor may defrosting be accelerated using a heat source!

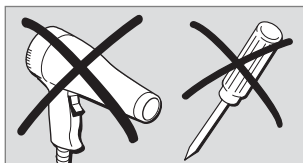

Fig. 38

4.10 Shutting off the refrigerator

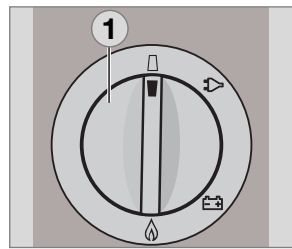

Fig. 39

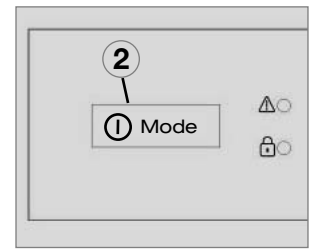

Fig. 40

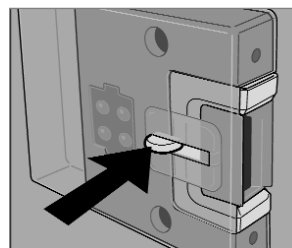

Fig. 41

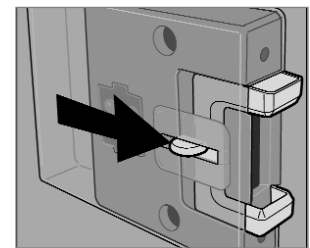

Fig. 42

- For battery igniter models, set energy selector switch "1" to position "OFF". The appliance is switched off (Fig. 39).
- Press the "MODE" button to switch off MES and AES models. Keep button "2" pressed for 3 seconds. The display disappears and the appliance is fully switched off (Fig. 40).
- Release the locking mechanism of the door lock by pushing it and shift it to the front. If the door is shut in this position, a small gap is nevertheless kept open to prevent formation of mildew.
- If the refrigerator is to be taken out of service for an extended period of time, close the on-board shut-off valve and the cylinder valve .

4.11 Exchange of the igniter's battery

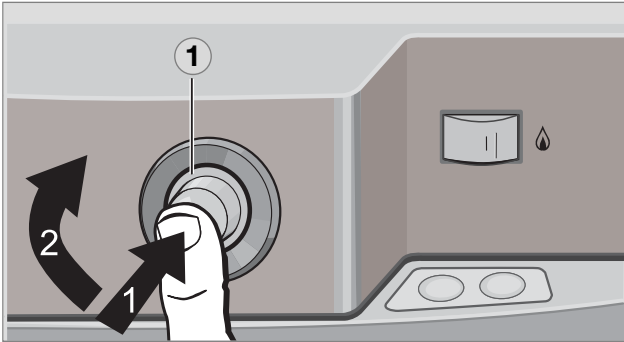

Fig. 43

Unlock the battery by depressing and turning the button (C) approx. 90° clockwise. Remove cap and exchange battery (1.5V AAA / R3 / Micro).

Observe correct polarity!

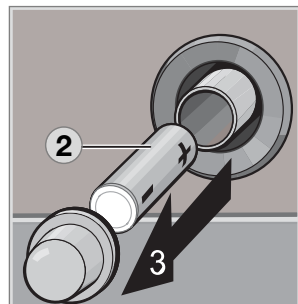

Fig. 44

4.12 Winter operation

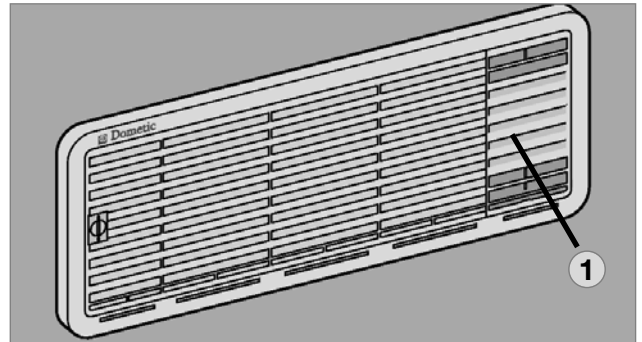

Fig. 45

In winter, check that the ventilation grilles and the exhaust duct system (1) have not been blocked by snow, leaves, etc..

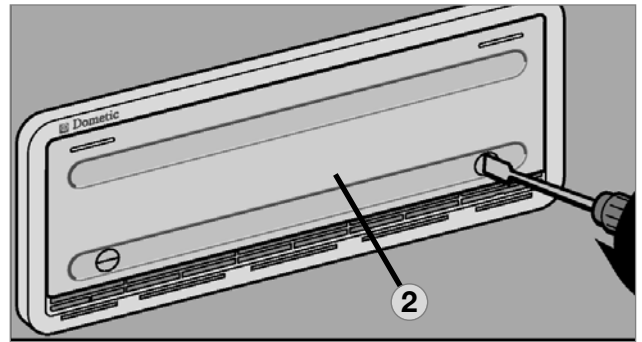

Fig. 46

When the outside temperature falls below **+10°C**, the **winter cover** should be fitted. This protects the unit from excessively cold air which could have adverse effects on the performance of the unit



You should also attach the winter cover if the vehicle is taken out of service for a longer period of time or while it is being cleaned from the outside

4.13 Changing the decor panel

Model RM 8xxx, RMS 8xxx

- Remove the lateral ledge (1) the door (ledge is attached, not screwed).
- Shift decor panel (2) away from the door and insert the new decor panel. Re-attach ledge (1) .

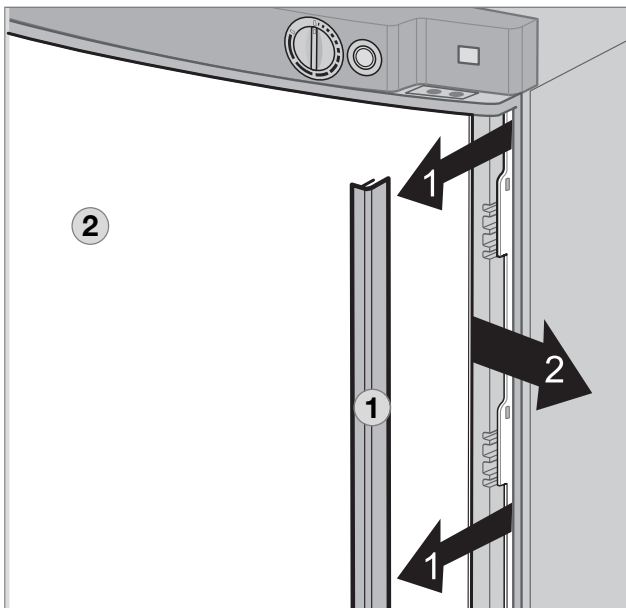

Fig. 47

Decor panel dimensions :

Casing width	486 mm	
Height	Width	Thickness
743 +/- 0.5 mm	472 +/- 0.5 mm	max. 2.2 mm

Casing width	523 mm	
Height	Width	Thickness
743 +/- 0.5 mm	510,5 +/- 1 mm	max. 2.2 mm

Model RM(S)L 8xxx

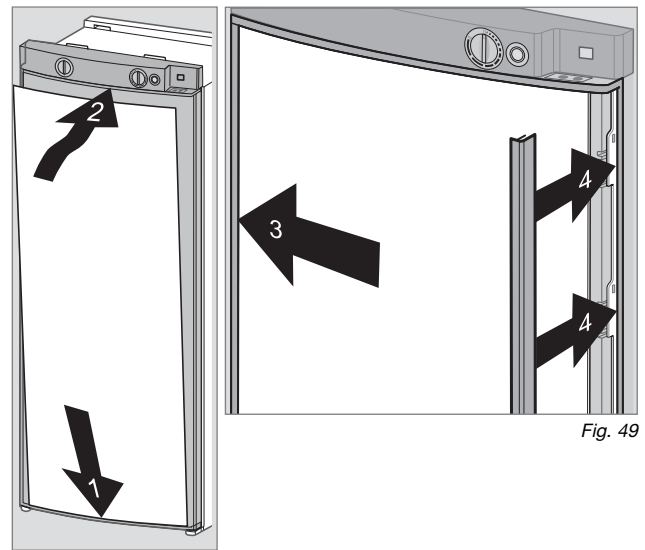

Fig. 49

Fig.48

VORSICHT!

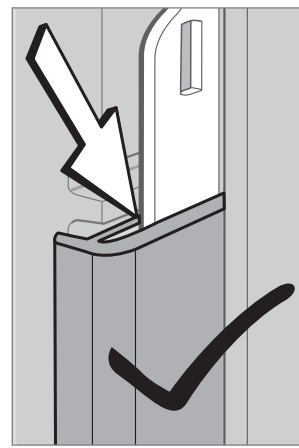

Fig. 50

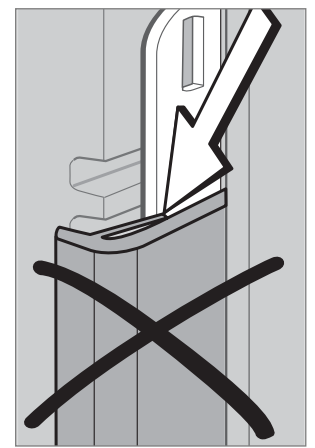

Fig.51

Decor panel dimensions :

Casing width	525 mm	
Height	Width	Thickness
1169,5 +/-1 mm	507,5 +/-1 mm	max. 1.7 mm

4.14 Information on failure display and trouble-shooting

- Refrigerators with an electronics system (MES, AES) indicate the occurrence of a malfunction by the LED or display flashing.
- If a malfunction occurs, the indicator LED "Failure" (1) flashes simultaneously. In the case of AES models an acoustic alarm sounds.

4.14.1 Status messages on the display

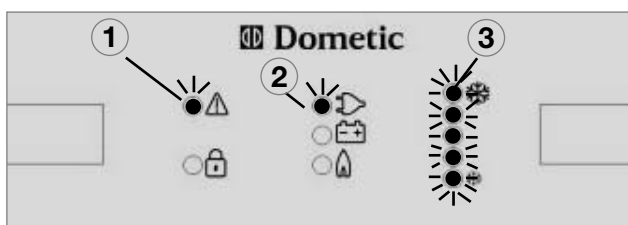

Fig. 52



Fig. 53

- ①: Indicator LED failure
- ②: Operating mode display
- ③: Temperature level display

Display :		Failure :
MES	AES	
LED is flashing	"230" is flashing	230V mode: "230V" not available or voltage too low
LED is flashing	"12" is flashing	12V mode: "12V" not available or voltage too low
LED is flashing	"GAS" is flashing	GAS/Auto mode: Flame not ignited
All temperature setting LEDs are flashing	All temperature setting LEDs are flashing	Temperature sensor defective, refrigerator works on mid temperature setting
LED + all temperature setting LEDs are flashing	"HE1" is flashing	230V - Heating element defective
LED + all temperature setting LEDs are flashing	"HE2" is flashing	12V - Heating element defective

4.14.2 Troubleshooting

Before notifying the authorised Service Center, please check whether:

- the instructions in section "Operating the refrigerator" have been observed.
- the refrigerator stands level.
- it is possible to operate the refrigerator with any available power source.

Failure: The refrigerator does not cool sufficiently.

Possible cause	Action you can take
■ Inadequate ventilation to the unit.	■ Check that the ventilation grilles are not covered.
■ Thermostat setting is too low.	■ Set thermostat to a higher level.
■ The condenser is heavily frosted.	■ Check that the refrigerator door closes properly.
■ Too much warm food has been stored inside within short period of time.	■ Allow warm food to cool down before storage.
■ The appliance has been running for only a short period of time.	■ Check whether the cooling compartment works after approx. 4 - 5 hours.
■ Ambient temperatures too high.	■ Regularly remove ventilation grilles.

Failure: The refrigerator does not cool in gas operation mode.

Possible cause	Action you can take
■ Gas cylinder empty.	■ Change gas cylinder.
■ Is the upstream shut-off device open ?	■ Open shut-off device.
■ Air in the gas pipe ?	■ Switch off the appliance and start again. Repeat this procedure 3 - 4 times, if necessary.

Failure: The refrigerator does not cool in 12V operation.

Possible cause	Action you can take
■ On-board fuse defective.	■ Fit new fuse.
■ On-board battery discharged.	■ Check battery, charge it.
■ Engine not running.	■ Start engine.
■ Heating element defective (please also refer to failure indication).	■ Please inform the Dometic Customer Services.

Failure: The refrigerator does not cool in 230V operation.

Possible cause	Action you can take
■ On-board fuse defective.	■ Fit new fuse.
■ Vehicle not connected to mains supply voltage.	■ Make a connection to a mains power supply.
■ AES: Gas operation despite connection to the mains supply voltage?	■ Appliance switches to gas operation due to insufficient mains supply voltage (automatically switches back to 230V operation).
■ Heating element defective (please also refer to failure indication).	■ Please inform the Dometic Customer Services.

