

**FURUNO**

# FI-504 MULTI Instrument



**FURUNO ELECTRIC CO., LTD.**

[www.furuno.co.jp](http://www.furuno.co.jp)

**OPERATOR'S MANUAL**

**ECF**

(Elemental Chlorine Free)

The paper used in this manual  
is elemental chlorine free.

© **FURUNO ELECTRIC CO., LTD.**

9-52 Ashihara-cho,  
Nishinomiya, 662-8580, JAPAN

Telephone : +81-(0)798-65-2111

Fax : +81-(0)798-65-4200

• FURUNO Authorized Distributor/Dealer

All rights reserved. Printed in Japan

Pub. No. OME-72690-A1

(DAMI ) FI-504

A : OCT. 2007

A1 : OCT. 17, 2007



\* 0 0 0 1 6 7 3 3 4 1 0 \*



# IMPORTANT NOTICES



---

- The descriptions in this manual are intended for readers with a solid knowledge of English.
- No part of this manual may be copied or reproduced without written permission.
- If this manual is lost or worn, contact your dealer about replacement.
- The contents of this manual and equipment specifications are subject to change without notice.
- The example screens (or illustrations) shown in this manual may not match the screens you see on your display. The screen you see depends on your system configuration and equipment settings.
- Store this manual in a convenient place for future reference.
- FURUNO will assume no responsibility for the damage caused by improper use or modification of the equipment (including software) by an unauthorized agent or a third party.
- When it is time to discard this product it must be done according to local regulations for disposal of industrial waste. For disposal in the USA, refer to the Electronics Industries Alliance (<http://www.eiae.org/>).







# SAFETY INSTRUCTIONS

The operator of this equipment must read these safety instructions before attempting to operate the equipment.

 <b>WARNING</b>	Indicates a potentially hazardous situation which, if not avoided, could result in death or serious injury.
 <b>CAUTION</b>	Indicates a potentially hazardous situation which, if not avoided, may result in minor or moderate injury.

 Warning, Caution	 Prohibitive Action	 Mandatory Action
--	--	--





## Safety instructions for the operator

 <b>WARNING</b>
 <b>Do not open the equipment.</b> Only qualified personnel should work inside the equipment.
 <b>Do not disassemble or modify the equipment.</b> Fire or electrical shock can result if the equipment is modified.
 <b>Do not operate the equipment with wet hands.</b> Electrical shock can result.
 <b>Make sure no rain or water splash leaks into the equipment.</b> Fire or electrical shock can result if water leaks into the equipment.
 <b>Immediately turn off the power at the switchboard if water leaks into the equipment.</b> Continued use of the equipment can cause fire or electrical shock.

### Warning Label

A warning label is attached to the equipment. Do not remove the label. If the label is missing or damaged, contact a FURUNO agent or dealer about replacement.

## Safety instructions for the installer

 <b>WARNING</b>						
 <b>Turn off the power at the switchboard before beginning the installation.</b> Turn off the power to prevent electrical shock.						
 <b>Make sure the installation site is not subject to water spray.</b> Fire or electrical shock can result if water leaks into the equipment.						
 <b>CAUTION</b>						
 <b>Observe the following compass safe distances to prevent interference to the instruments:</b>						
<table border="1"> <thead> <tr> <th></th> <th>Standard compass</th> <th>Steering compass</th> </tr> </thead> <tbody> <tr> <td>FI-50 series Instruments</td> <td>0.35 m</td> <td>0.30 m</td> </tr> </tbody> </table>		Standard compass	Steering compass	FI-50 series Instruments	0.35 m	0.30 m
	Standard compass	Steering compass				
FI-50 series Instruments	0.35 m	0.30 m				

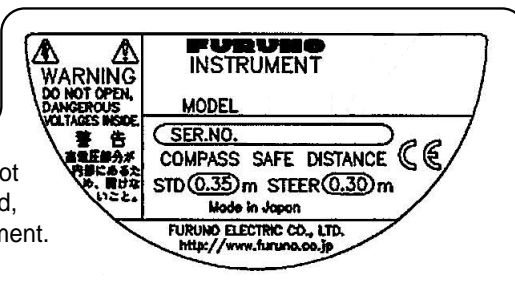

# TABLE OF CONTENTS

---

**FOREWORD** ..... **iv**

**SYSTEM CONFIGURATION** ..... **v**

**1. OPERATION** ..... **1**

    1.1 Operating Controls, Display Layout..... 1

    1.2 Turning the Power On/Off ..... 2

    1.3 Adjusting Brilliance and Contrast ..... 2

    1.4 Selecting a Display ..... 3

    1.5 Selecting Apparent or True Wind Angle, Wind Speed..... 8

    1.6 Resetting Counters and Indications ..... 8

    1.7 Alarms ..... 9

    1.8 Timers ..... 11

**2. MAINTENANCE, TROUBLESHOOTING** ..... **13**

    2.1 Preventive Maintenance..... 13

    2.2 Troubleshooting..... 14

**3. INSTALLATION** ..... **15**

    3.1 Equipment Lists..... 15

    3.2 Mounting..... 16

    3.3 Wiring ..... 18

    3.4 Setting Up..... 21

**SPECIFICATIONS** ..... **SP-1**

**PACKING LIST** ..... **A-1**

**OUTLINE DRAWINGS**..... **D-1**

**INTERCONNECTION DIAGRAM** ..... **S-1**

# FOREWORD

---

## A Word to the Owner of the FI-504

Congratulations on your choice of the FURUNO FI-504 Multi Display, a member of the FI-50 series of marine instruments. We are confident you will see why the FURUNO name has become synonymous with quality and reliability.

For over 50 years FURUNO Electric Company has enjoyed an enviable reputation for quality marine electronics equipment. This dedication to excellence is furthered by our extensive global network of agents and dealers.

This equipment is designed and constructed to meet the rigorous demands of the marine environment. However, no machine can perform its intended function unless operated and maintained properly. Please carefully read and follow the recommended procedures for operation and maintenance.

Thank you for considering and purchasing FURUNO equipment.

## Features

The FI-504 Multi Display provides heading, environment, autopilot, engine, depth, speed, and wind information, all on a high quality, backlit LCD. The sturdy weather-proof case is built to stand up to even the harshest of environments.

The main features are

- Eight varieties of displays: heading, environment, autopilot, engine, depth, speed, timer, and wind.
- Four levels of backlighting including off.
- Timers: Stopwatch and count-down
- Depth alarms: Shallow alarm, Deep alarm
- Anchor alarms: Shallow alarm, Deep alarm
- Voltage alarm monitors power source voltage
- Wind alarms: High apparent wind angle, Low apparent wind angle, Max. true wind speed, Low true wind speed
- Speed indications: Max. STW, Average STW, SOG, Max. SOG, Average SOG, Wind speed, Max. true wind speed
- Log indication from 0 to 99,999 nm
- Resettable trip counter, from 0 to 999 nm

# SYSTEM CONFIGURATION

---

## Standalone configuration

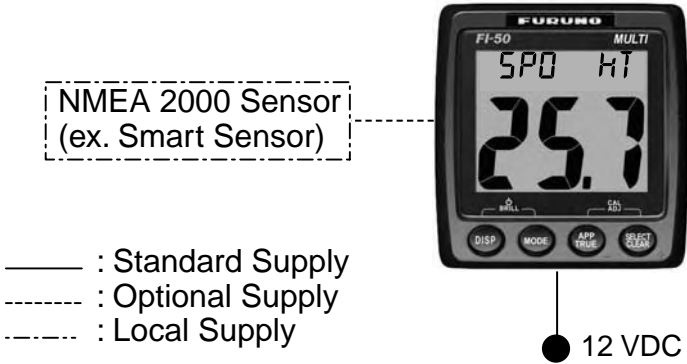

**NOTICE:** Turn on the terminal resistor in the instrument when connecting an NMEA 2000 sensor. For the procedure, see the section on setting up, in the installation chapter.

**NMEA 2000 network**

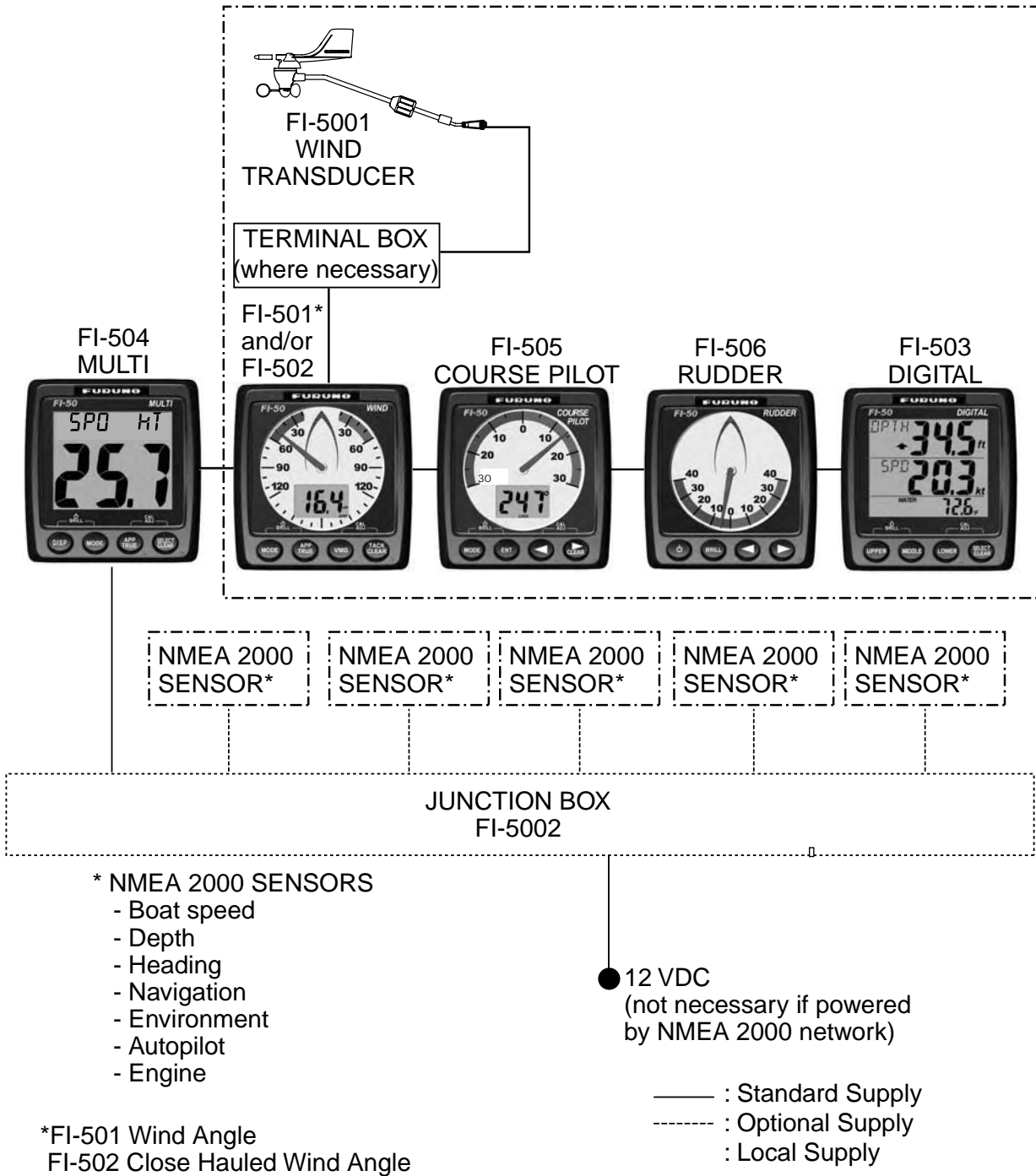

**NOTICE:** Turn on the terminal resistor in the terminator of the NMEA 2000 network.



# 1. OPERATION

---

Provided applicable sensors are connected, the FI-504 provides the following information, all on a backlit LCD:

- Depth
- Speed
- Heading
- Environment data
- Autopilot (rudder)
- Engine
- Wind
- Timers
- Navigation data

## 1.1 Operating Controls, Display Layout

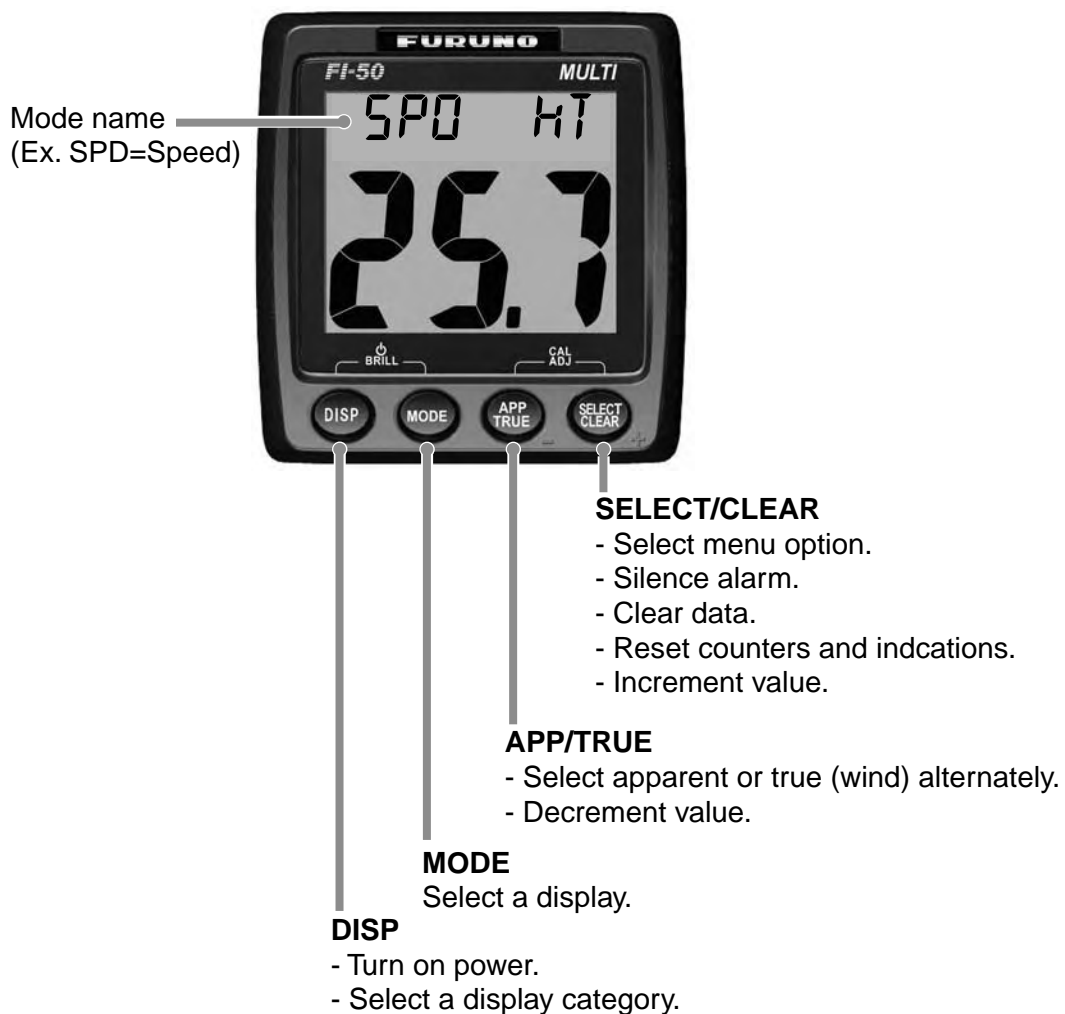

## 1.2 Turning the Power On/Off

To power the instrument, press the **DISP** key. All LCD segments go on and off and then the last-used display appears.

To power off the instrument, press the **DISP** and **MODE** keys together (about 7-10 seconds). The timer appears and counts down from three seconds to one second, and then the power goes off.

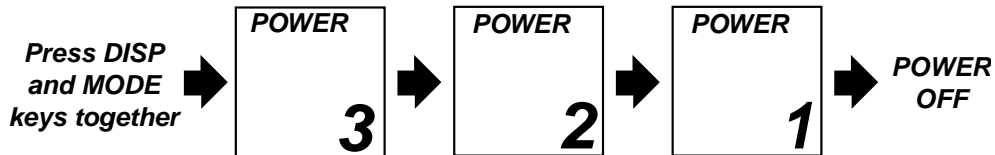

*Power OFF sequence*

## 1.3 Adjusting Brilliance and Contrast

1. Press the **DISP** and **MODE** keys together. The display for adjustment of brilliance appears, with current brilliance setting flashing.

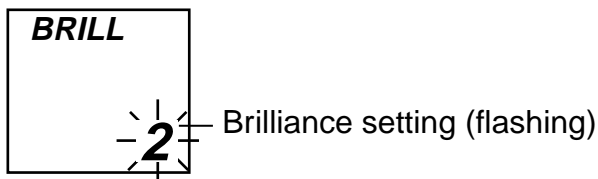

2. Within seven seconds of completing step 1, press the **APP/TRUE** key to lower the brilliance, or the **SELECT/CLEAR** key to raise it.

3. Press the **DISP** and **MODE** keys together. The display for adjustment of contrast appears, with current contrast setting flashing.

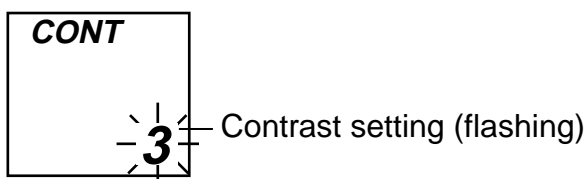

4. Within seven seconds of completing step 3, press the **APP/TRUE** key to lower the contrast, or the **SELECT/CLEAR** key to raise it.

5. Press the **DISP** and **MODE** keys together to save the settings and restore normal operation.

The brilliance and contrast will be the same on all units which are synchronized. (For how to synchronize units, see page 26.)

## 1.4 Selecting a Display



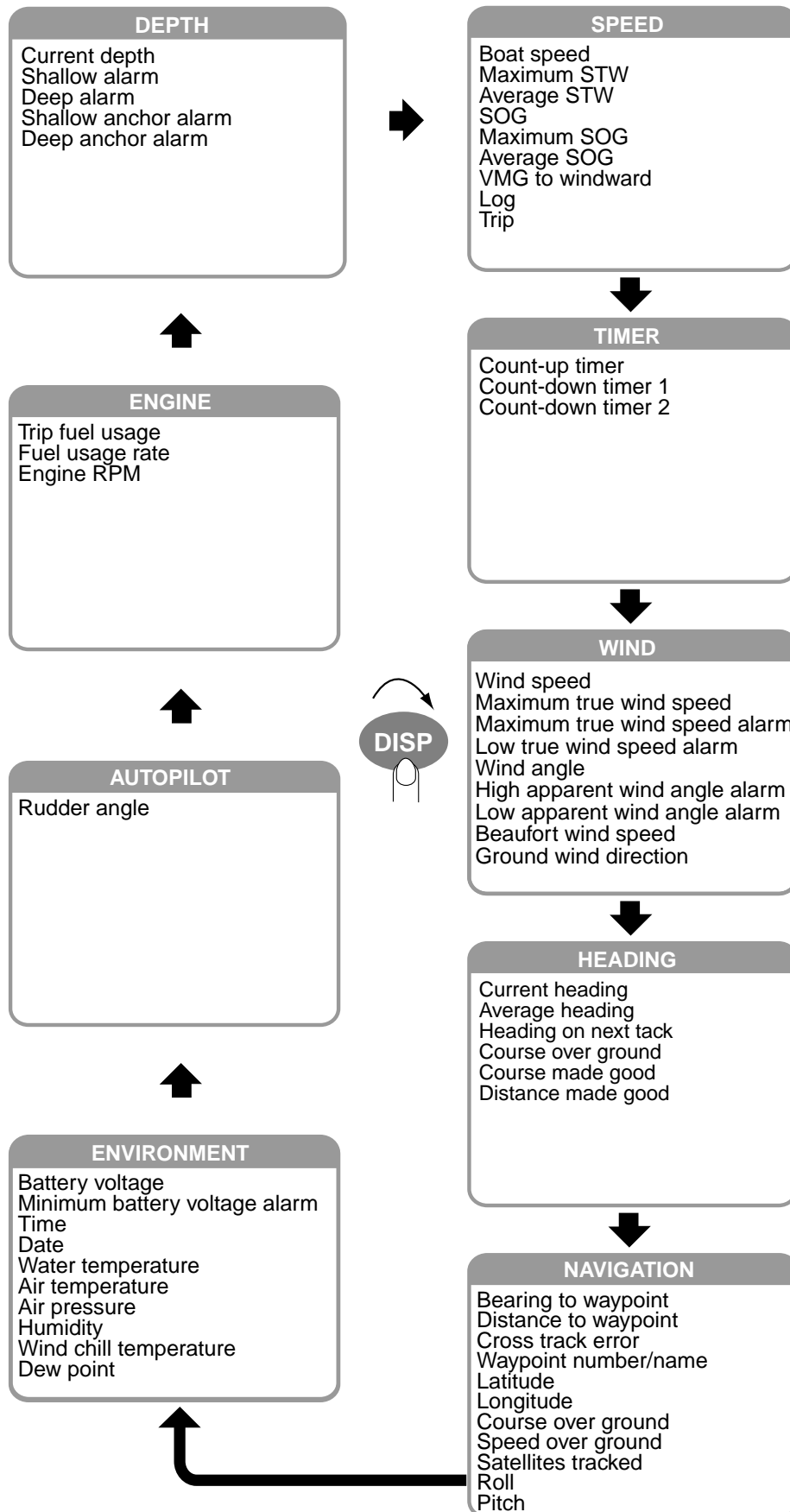



Use the **DISP** key to select a display category. Select desired display with the **MODE** key.



1. OPERATION

1.4.1 Display description

Depth category

Display title	Indication	Function
Current depth	DPTH	Current depth, in meters, feet or fathoms.
Shallow alarm	 SHALLOW	Set shallow depth alarm. Audio and visual alarms are released when the depth is lower than the threshold value.
Deep alarm	 DEEP	Set deep depth alarm. Audio and visual alarms are released when the depth is higher than the threshold value.
Shallow anchor alarm	  SHALLOW	Set shallow anchor alarm. Audio and visual alarms are released when the depth is lower than the threshold value.
Deep anchor alarm	  DEEP	Set deep anchor alarm. Audio and visual alarms are released when the depth is higher than the threshold value.





Speed category

Display title	Indication	Function
Boat speed	SPD	Boat speed, in knots (kt), miles per hour (MPH) or kilometers per hour (KMH).
Maximum STW	SPD MAX	Maximum boat speed, in knots (kt), miles per hour (MPH) or kilometers per hour (KMH).
Average STW	SPG AVG	Average boat speed, in knots (kt), miles per hour (MPH) or kilometers per hour (KMH).
SOG	SOG	Speed over ground, in knots (kt), miles per hour (MPH) or kilometers per hour (KMH).
Maximum SOG	SOG MAX	Maximum speed over ground, in knots (kt), miles per hour (MPH) or kilometers per hour (KMH).
Average SOG	SOG AVG	Average speed over ground, in knots (kt), miles per hour (MPH) or kilometers per hour (KMH).
VMG to windward	VMG	Velocity made good to windward, in knots (kt), miles per hour (MPH) or kilometers per hour (KMH).
Log	LOG	Log distance (total distance run), in nautical miles (NM), kilometers (KM) or statute miles (SM).
Trip	TRIP	Trip distance (distance run between two points), in nautical miles (NM), kilometers (KM) or statute miles (SM).

**Timer category**

Display title	Indication	Function
Count up timer	UP	Count-up timer.
Count down timer 1	DOWN 1	Count-down timer 1.
Count down timer	DOWN 2	Count-down timer 2.

**Wind category**

Display title	Indication	Function
Wind speed	APP (or TRUE)	Wind speed, in knots or meters/second.
Maximum true wind speed	MAX TRUE	Maximum true wind speed.
Maximum true wind speed alarm	 MAX TRUE	Set maximum true wind speed alarm. Audio and visual alarms are released when the wind speed goes higher than the threshold value.
Low true wind speed alarm	 TRUE LO	Set low true wind speed alarm. Audio and visual alarms are released when the wind speed goes lower than the threshold value.
Wind angle	APP (or TRUE)	Apparent (or true) wind angle, in degrees.
High apparent wind angle alarm	 APP HI	Set high apparent wind angle alarm. Audio and visual alarms are released when the wind angle at starboard goes higher than the threshold value.
Low apparent wind angle alarm	 APP LO	Set low apparent wind angle alarm. Audio and visual alarms are released when the wind angle at port goes lower than the threshold value.
Beaufort wind speed	BFT	Beaufort wind speed. Beaufort speeds up to 12 are shown. See the table below for Beaufort no. and wind speed.
Ground wind angle	GWIND	Angle of wind over ground, in degrees. Bearing reference in Magnetic (MAG) or True (TRUE).

**Beaufort no. and wind speed**

Beaufort no.	Wind speed		Beaufort no.	Wind speed	
	kt	m/s		kt	m/s
0	0	0-0.2	7	28-33	14.4-17.4
1	1-3	0.5-2.0	8	34-40	17.5-21.0
2	4-6	2.1-3.5	9	41-47	21.1-24.6
3	7-10	3.6-5.6	10	48-55	24.7-28.8
4	11-16	5.7-8.6	11	56-63	28.9-32.6
5	17-21	8.7-11.2	12	64	32.7-32.9
6	22-27	11.3-14.3			

1. OPERATION

**Heading category**

<b>Display title</b>	<b>Indication</b>	<b>Function</b>
Current heading	HDG	Heading, in degrees. Bearing reference in Magnetic (MAG) or True (TRUE).
Average heading	HDG AVG	Average heading, in degrees. Bearing reference in Magnetic (MAG) or True (TRUE).
Heading on next tack	TACK	Heading on next tack, in degrees true (fixed). Bearing reference in Magnetic (MAG) or True (TRUE).
Course over ground	COG	Course over ground, in degrees.
Course made good	CMG	Course made good, in degrees.
Distance made good	DMG	Distance made good, in kilometers (km), nautical miles (nm) or statute miles (sm).

**Navigation category**

<b>Display title</b>	<b>Indication</b>	<b>Function</b>
Bearing to waypoint	BTW	Bearing to waypoint, in degrees. Bearing reference of Magnetic (MAG) or True (TRUE)
Distance to waypoint	DTW	Distance to waypoint, in kilometers (KM), nautical miles (NM) or statute miles (SM).
Cross track error	XTE	Cross-track error, in kilometers (KM), nautical miles (NM) or statute miles (SM).
Waypoint number/name	WPT	Waypoint number and name are shown.
Latitude	LAT	Position in latitude.
Longitude	LON	Position in longitude.
Course over ground	COG	Course over ground, in degrees. Bearing reference in Magnetic (MAG) or True (TRUE).
Speed over ground	SOG	Speed over ground, in knots (K), miles per hour (MPH) or kilometers per hour (KMH).
Satellites tracked	GPS SAT	GPS satellites tracked.
Roll	ROLL	Ship's roll, in degrees.
Pitch	PITCH	Ship's pitch, in degrees.

**Environment category**

Display title	Indication	Function
Battery voltage	VOLTS	Battery voltage.
Minimum battery voltage alarm	 VOLTS LO	Set low battery voltage alarm. Audio and visual alarms are released when the battery voltage goes lower than the threshold value.
Time	-	Current time, in 12-hour or 24-hour format.
Date	-	Current date.
Water temperature	WATER	Water temperature, in °C or °F.
Air temperature	AIR°	Air temperature, in °C or °F.
Air pressure	HPA	Air pressure, in Hectopascal.
Humidity	HUMID	Relative humidity, in percentage.
Wind chill temperature	CHILL	Wind chill temperature, in °C or °F.
Dew point	DEW	Dew point, in °C or °F.

**Autopilot category**

Display title	Indication	Function
Rudder angle	RUDDER	Rudder angle, in degrees either P(ort) or S(tarboard).

**Engine category**

Display title	Indication	Function
Trip fuel used	TOTAL	Total fuel consumption, in liters or gallons.
Fuel rate	RTE (L/H)	Amount of fuel consumed in hour, in liters/hour (L/H) or gallons/hour (G/H).
Engine RPM	RPM	Engine speed per minute.

**Note:** In case of multiple engines, the data of desired engine number (max. eight, E0-E7) can be selected with the **SELECT/CLEAR** key.

***Scrolling speed and scrolling direction***

Display scrolling speed and direction can be changed by the length of key push.

**Short push:** Scroll in forward order.

**Medium push:** Go back one display. Several beeps sound and then the previous display appears.

**Hold down:** Rapid scrolling, in forward direction. Several beeps sound and then speed is changed.

## 1.5 Selecting Apparent or True Wind Angle, Wind Speed

You can show wind angle and wind speed in apparent or true wind. The **apparent wind** is the actual flow of air acting upon a sail, or the wind as it appears to the sailor. **True wind** is the wind seen by a stationary observer in velocity and direction.

With a wind angle or wind speed indication displayed, press the **APP/TRUE** key to change the wind angle or wind speed to apparent and true alternately. A beep sounds after the change is completed. (Wind angle and wind speed displays are mutually changed.) True wind requires boat speed input. If there is no speed input three dashes appear.

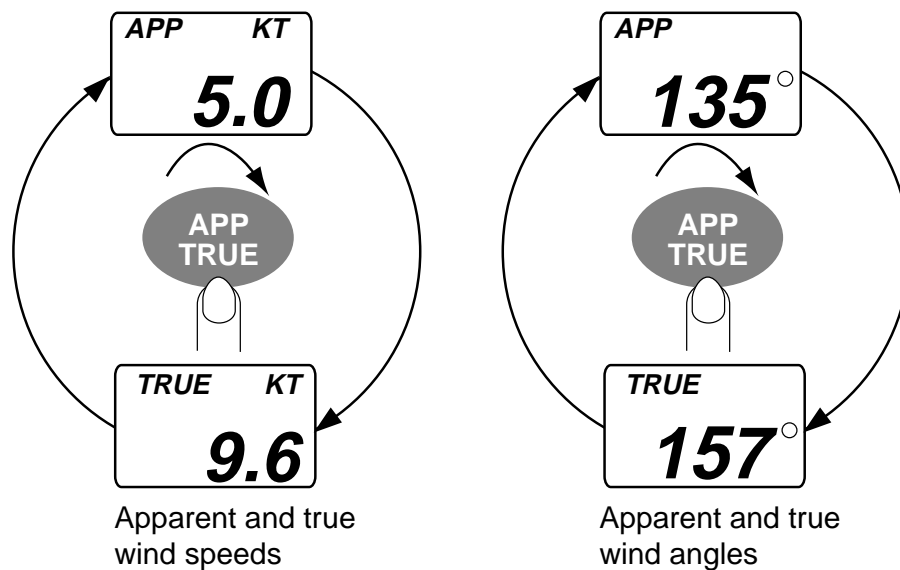

## 1.6 Resetting Counters and Indications

You can reset the following counters and indications:

- Trip distance
- Course made good
- Distance made good
- Average speed
- Average SOG
- Maximum speed
- Maximum SOG
- Average heading
- Maximum true wind speed





Select the applicable display and press and hold down the **SELECT/CLEAR** key. A short beep sounds, the counter or indication flashes twice and then a long beep sounds to indicate that resetting is completed.

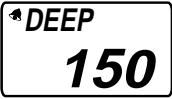
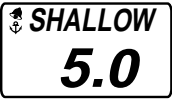
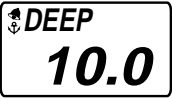
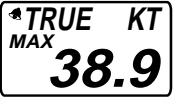

## 1.7 Alarms

There nine conditions which trigger audio and visual alarms: Shallow alarm, Deep alarm, Shallow anchor alarm, Deep anchor alarm, Max. true wind speed alarm, Low true wind speed alarm, High apparent wind angle alarm, low apparent wind angle alarm, and low battery voltage alarm.

1. Use the **DISP** and **MODE** keys to select desired alarm page, referring to the illustration below for alarm location.

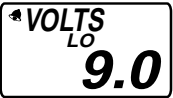
Display category	Available alarms			
DEPTH	 Shallow alarm	 Deep alarm	 Shallow anchor alarm	 Deep anchor alarm
WIND	 Max. true wind speed alarm	 Low true wind speed alarm	 High apparent wind angle alarm	 Low apparent wind angle alarm
ENVIRONMENT	 Low voltage alarm			

\*S (Starboard) or P (Port)

### Alarm description

Alarm	Alarms released when;	Setting range
Shallow alarm	depth is shallower than this threshold.	0.0-303 m
Deep alarm	depth is deeper than this threshold.	0.1-304 mt
Shallow anchor alarm	anchor depth is shallower than this threshold.	depth is shallower than this threshold.
Deep anchor alarm	anchor depth is greater than this threshold.	depth is deeper than this threshold.
Max. true wind speed alarm	max. true wind speed is greater than this threshold.	0.1-999 kts
Low true wind speed alarm	true wind speed is lower than this threshold.	0-998 kts
High apparent wind angle alarm	apparent wind angle is higher than this threshold.	0°-179° S180°-P1°
Low apparent wind angle alarm	apparent wind angle is lower than this threshold.	(S=Starboard, P=Port)

*Alarm description*

Alarm	Alarms released when;	Setting range
Low battery voltage alarm	battery voltage is lower than this threshold.	5.0 - 20.0 volts

2. If the selected alarm page shows “Off,” press and hold down the **SELECT/CLEAR** key until an alarm setting appears.
3. Press the **APP/TRUE** and **SELECT/CLEAR** keys together to enable adjustment. The alarm setting starts flashing.
4. Press the **APP/TRUE** key to lower the setting; the **SELECT/CLEAR** key to raise it.  
**Note:** A low alarm cannot be set higher than its affiliated high (max.) alarm.
5. Press the **APP/TRUE** and **SELECT/CLEAR** keys together to confirm setting and restore normal operation.

When an alarm is violated, the buzzer sounds and the alarm icon (  ) flashes. You can silence the buzzer with the **SELECT/CLEAR** key. The icon continues flashing until the offending alarm is disabled.

While the icon is flashing you can switch between alarm display and current display alternately by pressing the **DISP** and **SELECT/CLEAR** keys together.

## 1.8 Timers

Three timers are provided:

- Count-up timer (stopwatch)
- Count-down timer (two provided)

Time is displayed in seconds or minutes, depending on counter values.

Once you have set a timer, you can leave that page and select any other display. The counter continues to run in the background.

### Count-up timer

The count-up timer functions like a stop watch, counting time upward, to 99 hours, 99 minutes and 59 seconds.

### Count-down timers

The two count-down timers count down from a time between 15 minutes and one minute. When these timers have counted down to zero, they then start counting up. The timers beep at preset intervals to alert you to specific points in time.

- Two beeps every minute
- Three beeps at the start of the last 30 seconds
- One beep/second for each of the last 10 seconds
- Two-second beep at zero

### How to set the timers

1. Press the **MODE** key to show the desired timer display.



Count-up  
timer



Count-down  
timer 1

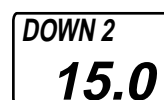

Count-down  
timer 2

2. Do one of the following depending on timer type selected:

#### **Count-up timer:**

Press the **SELECT/CLEAR** key to start the timer. A long beep sounds and the timer starts counting upward.

#### **Count-down timer:**

To start the timer from the time shown, press the **SELECT/CLEAR** key. To set a different start time, press the **APP/TRUE** and **SELECT/CLEAR** keys together to enable adjustment. Use the **APP/TRUE** key to lower the value; **SELECT/CLEAR** key to raise it. Press the **APP/TRUE** and **SELECT/CLEAR** keys together to confirm setting. Press the **SELECT/CLEAR** key to start the timer.

## 1. OPERATION



**To stop or restart the timer**, press the **SELECT/CLEAR** key momentarily. A short beep sounds when the timer is stopped or restarted.

**To stop and reset the timer to start value**, press the **SELECT/CLEAR** key until you hear a long beep. The timer is stopped and reset to start value.

The timer settings are reflected on any timer-equipped instrument in the network which is set up for synchronization.

# 2. MAINTENANCE, TROUBLESHOOTING

This chapter provides the information necessary for keeping your equipment in good working order.

 <b>WARNING</b>	
	<p><b>Do not open the equipment.</b></p> <p>Only qualified personnel should work inside the equipment.</p>

## 2.1 Preventive Maintenance

Following the recommended procedures below will help maintain performance.

Check item	Check point	Remedy
Cabling	Check that all cabling is securely fastened and is free of rust and corrosion.	Reconnect if necessary. Replace if damaged.
Cabinet	Dust on cabinet	<p>Remove dust with a soft, lint-free cloth.</p> <div style="border: 1px solid black; padding: 10px; margin-top: 10px;"> <p style="text-align: center;"><b>NOTICE</b></p> <p><b>Do not apply paint, anti-corrosive sealant or contact spray to coating or plastic parts of the equipment.</b></p> <p>Those items contain organic solvents that can damage coating and plastic parts, especially plastic connectors.</p> </div>

## 2.2 Troubleshooting

If you feel the equipment is not functioning properly, follow the procedures in the table below to try to restore normal operation. If normal operation cannot be restored, do not attempt to check inside the cabinet. There are no user-serviceable parts inside.

### Troubleshooting

<b>Problem</b>	<b>Possible cause</b>	<b>Remedy</b>
Display is blank. Panel is not lit.	<ul style="list-style-type: none"> <li>• Power supply</li> <li>• Cabling disconnected or damaged.</li> </ul>	<ul style="list-style-type: none"> <li>• Check power supply.</li> <li>• Check cabling.</li> </ul>
Power is on but no or some data.	<ul style="list-style-type: none"> <li>• Sensor is turned off.</li> <li>• Cable from sensor is disconnected or damaged.</li> </ul>	<ul style="list-style-type: none"> <li>• Turn on sensor.</li> <li>• Check cabling.</li> </ul>
Inaccurate data	<ul style="list-style-type: none"> <li>• Electromagnetic field generating equipment is in operation.</li> <li>• Cabling from sensor is damaged.</li> <li>• Sensor is improperly aligned (where applicable).</li> </ul>	<ul style="list-style-type: none"> <li>• Turn off all electromagnetic field generating equipment. Turn them on and off one by one. Check the display. Relocate offending equipment or this instrument as appropriate.</li> <li>• Check cabling.</li> <li>• Check installation. If installation is proper, an offset may be applied to certain data. For details, see section 1.7.</li> </ul>

# 3. INSTALLATION

---

## NOTICE

**Do not apply paint, anti-corrosive sealant or contact spray to coating or plastic parts of the equipment.**

Those items contain organic solvents that can damage coating and plastic parts, especially plastic connectors.

## 3.1 Equipment Lists

### Standard supply

Name	Type	Code No.	Qty	Remarks
Display Unit	FI-504	-	1	
Installation Materials	CP26-00600	000-011-744	1 set	See packing list at end of manual for details.

### Optional supply

Name	Type	Code No.	Qty	Remarks
Cable Assy.	FI-50-DROP	000-166-945-10	1	
	FI-50-CHAIN-0.3M	000-166-949-10	1	
	FI-50-CHAIN-5M	000-166-951-10	1	
	FI-50-CHAIN-1M	000-166-950-10	1	
	FI-50-CHAIN-10M	000-166-952-10	1	
	FI-50-CHAIN-20M	000-166-953-10	1	
Flush Mount Kit	FI-50-FLUSH-KIT	000-010-619	1 set	
Junction Box	FI-5002	000-010-765	1 set	

## 3.2 Mounting

The display unit can be installed two ways: surface mount (fixed at front panel or fixed from rear panel) and flush mount (optional kit required). This section covers surface mounting. For flush mounting, see the flush mounting instructions, issued separately.

### **Surface mount 1: Fix instrument from front panel**

1. Using the template at the back of this manual, open a mounting hole in the installation site.
2. Detach the front panel together with the keypad assy. Attach sponge (supplied) to rear of display unit.
3. Set the display unit to the mounting hole, and fix it with four self-tapping screws (3x20, supplied).
4. Attach the front panel and keypad assy. to the display unit.

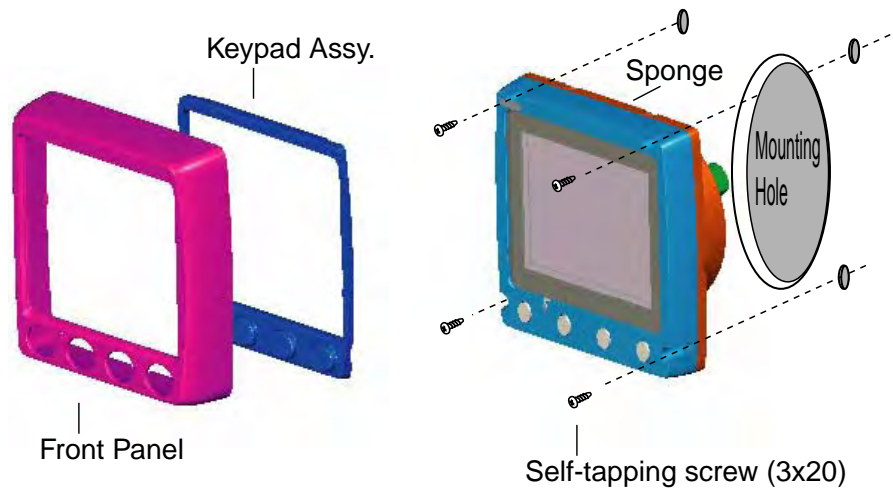



**Surface mount 2: Fix instrument from rear panel**

1. Using the template at the back of this manual, open a mounting hole in the installation site.
2. Insert studs (M3x40, 2 pcs., supplied) in the holes shown below. (Use only the studs supplied.)

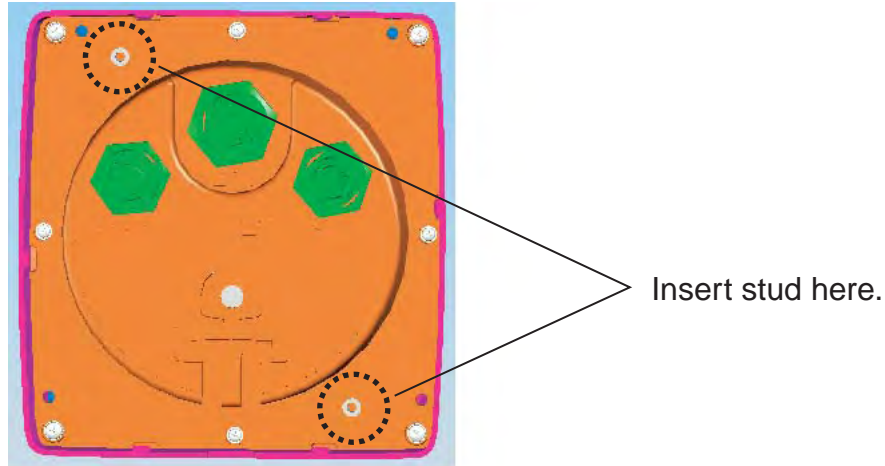

3. Set the display unit to the mounting hole, inserting studs through respective holes. Fix the display unit with wing nuts (M3, supplied).

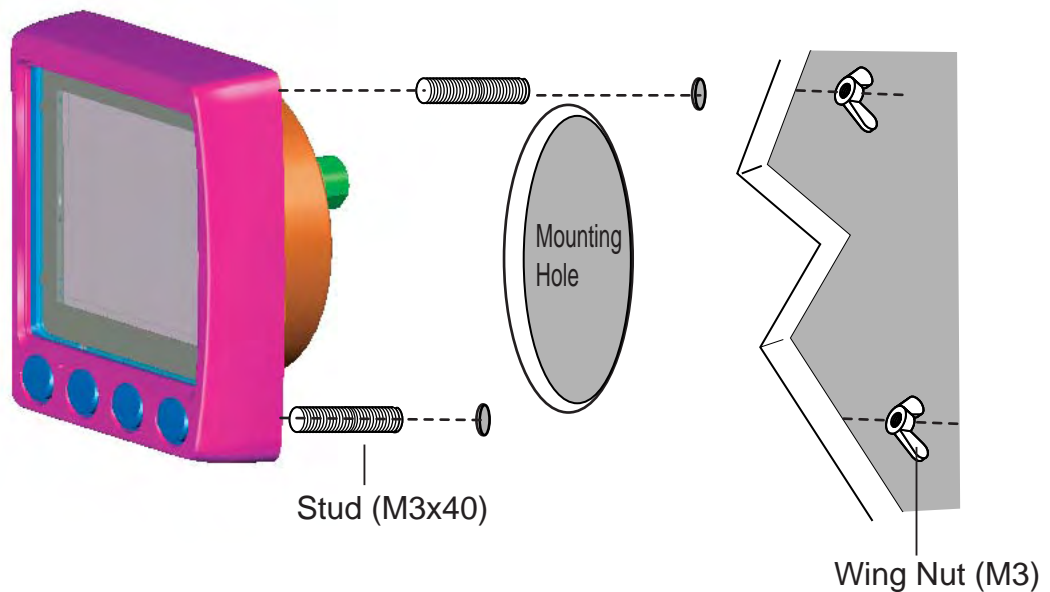

### 3.3 Wiring

#### 3.3.1 Standalone configuration

For standalone configuration the junction box is not necessary; connect the instrument directly to the power supply.

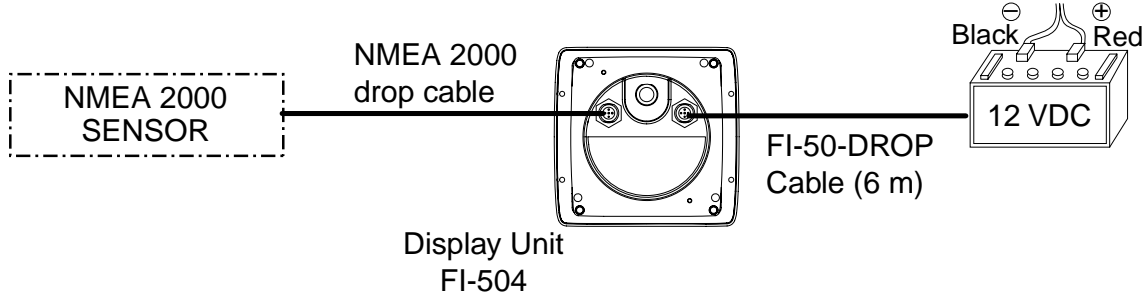

#### 3.3.2 Multi-instrument configuration

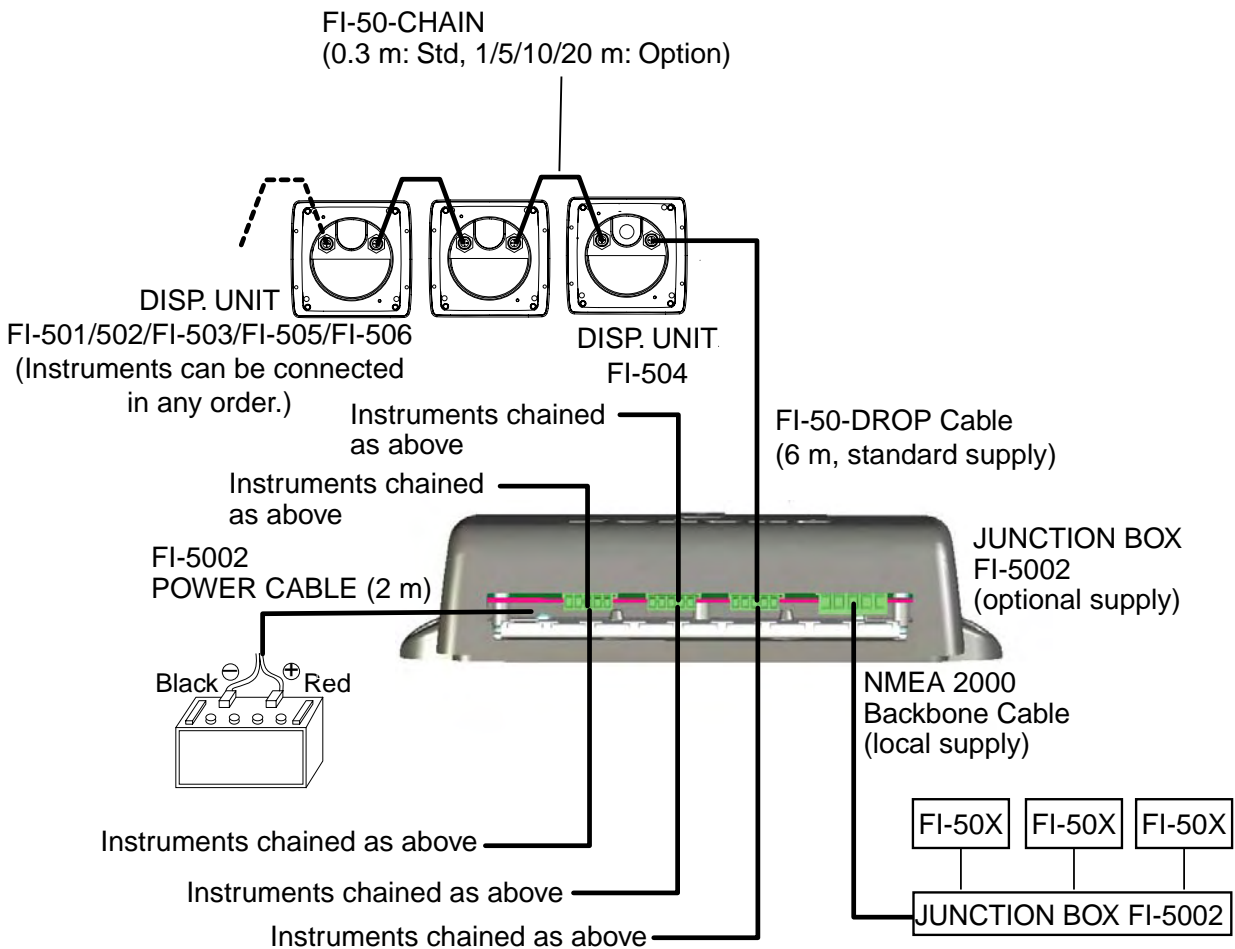

The total length of drop cables and backbone cables must be within 80 m.

### **Junction box (option)**

The junction box is required when connecting NMEA 2000 network. This section covers wiring of the junction box. For how to mount the junction box, see its installation instructions, issued separately.

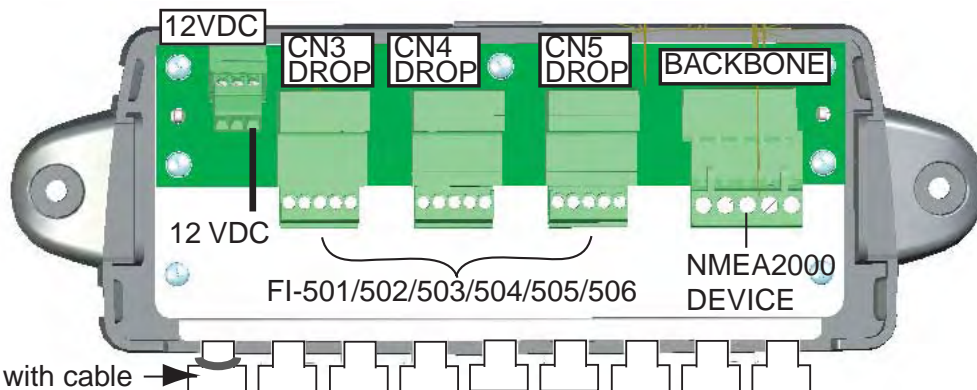

Fix cable with cable tie (supplied).

CH3 DROP - CH5 DROP and BACKBONE are socket-and-plug-type terminal blocks. Detach plug to connect wiring to it, by rocking it back and forth with your fingers. Remove approx. 6 mm of the sheath from the end of wires and twist wires. Loosen fixing screw in the plug, insert wire into hole and tighten fixing screw. Set plug to socket.

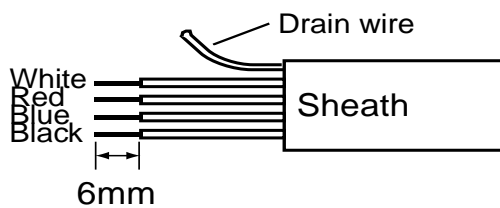

*How to fabricate cable*

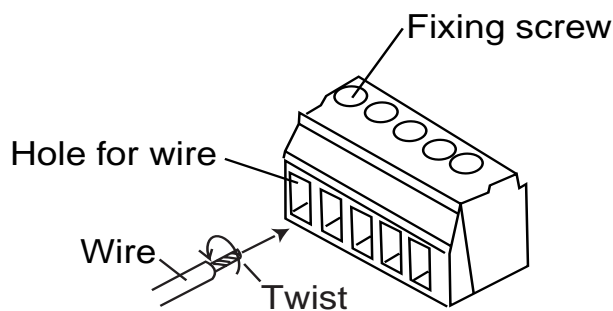

*How to insert wire*

**Terminal resistor**

The illustration below show various system configurations and what units to activate the terminal resistor.

**Smart sensor+FI-50x**

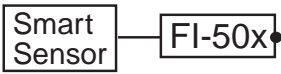

**Multiple FI-50 series instruments, FI-5002, drop cabling**

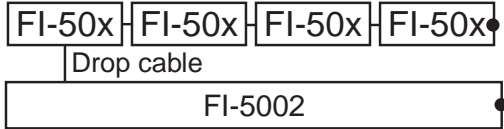

**Multiple FI-50 series instruments, FI-5002**

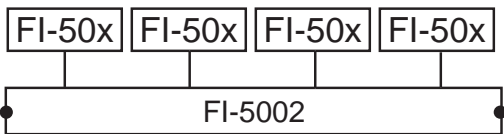

**Multiple FI-50 series instruments, multiple FI-5002**

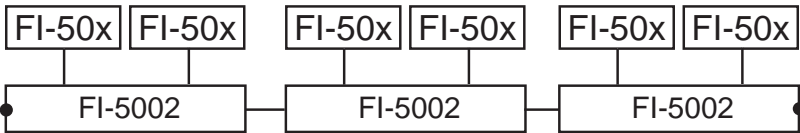

**Multiple FI-50 series instruments, FI-5002, smart sensor**

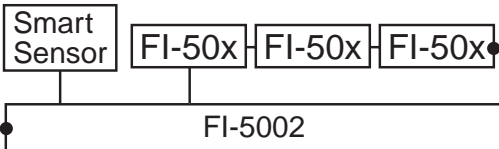

**Multiple FI-50 series instruments, FI-5002, heading sensor, smart sensor**

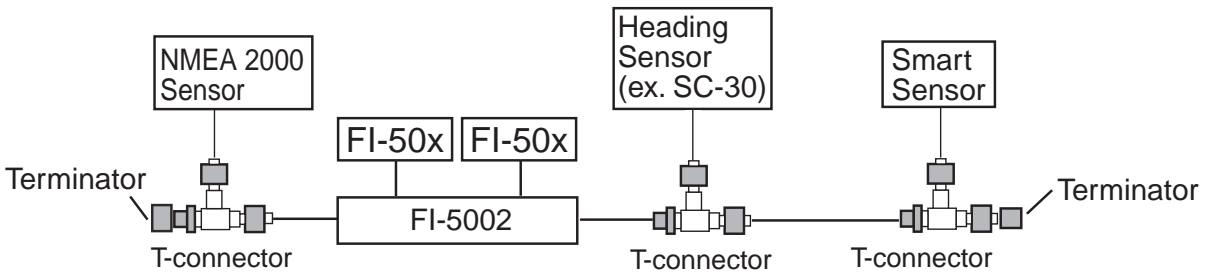

**Multiple FI-50 series instruments, FI-5002, NMEA 2000 sensors**

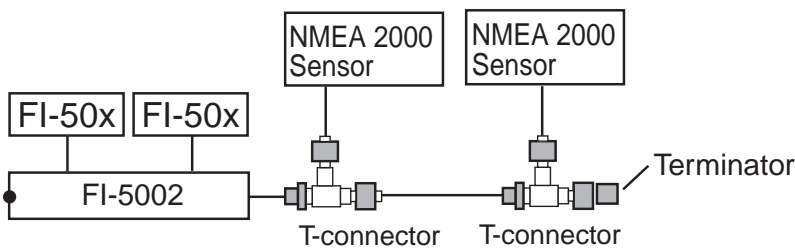

• = Terminal resistor ON

Turn on the terminal resistor in the junction box when the NMEA 2000 sensor(s) connected to it do not have a terminal resistor.

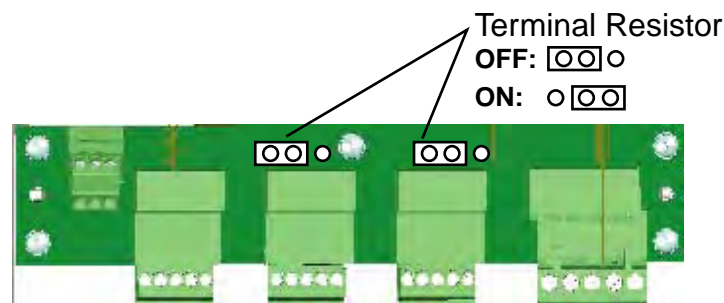

For how to turn on the terminal resistor in a FI-50 series instrument, see page 33 (FI-501//FI-502/FI-505) or page 35 (FI-506).

## 3.4 Setting Up

Your instrument is pre-programmed with factory default settings, which may or may not be suited to your vessel. Therefore, it is necessary to initialize the instrument for use with your vessel. This should be done immediately after completion of the installation.

Two sets of setup menus are provided: setup1 and setup2. The setup1 menu provides system parameters and the setup2 menu has user settings.

### 3.4.1 Setup1 menu

The setup1 menu contains system parameters which optimize the instrument for use on your vessel. Follow the procedure below to access and set parameters.

1. Press the **APP/TRUE** and **SELECT/CLEAR** keys momentarily to enable the setup1 menu. The Depth unit selection screen appears, with the depth unit flashing. (See the illustration on the next page.)
2. Use the **DISP** key to select a menu item. Each press of the key changes the menu item in the sequence shown in the illustration on the next page.

### 3. INSTALLATION

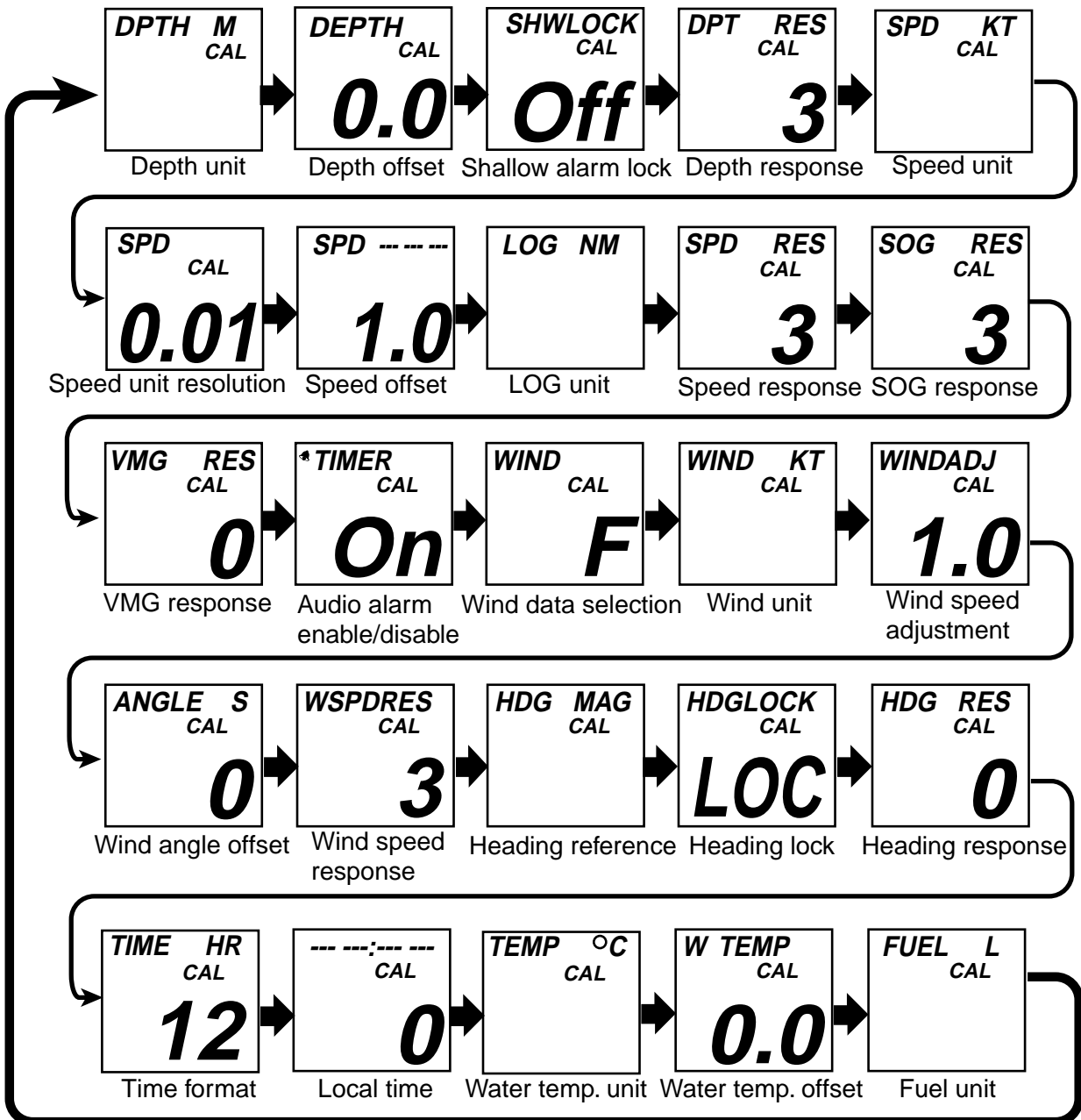

3. Use the **APP/TRUE** or **SELECT/CLEAR** key to set value or select option.



**VMG** key: Decrement value

**SELECT/CLEAR** key: Increment value or select option.

4. To continue, press the **DISP** key to select another menu item.

5. To save settings and restore normal operation, press the **APP/TRUE** and **SELECT/CLEAR** keys together.

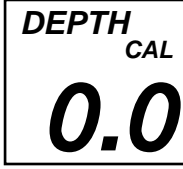
Setup1 menu items

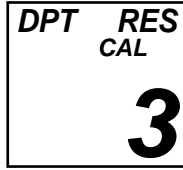
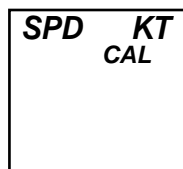
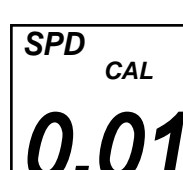
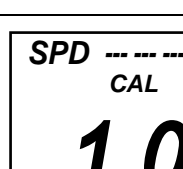
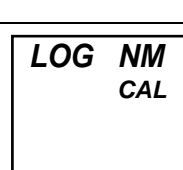



Display	Function	Setting range or options	Default setting
	Select depth unit.	M (Meter), FT (Feet)	M
	Set depth offset.	-99 - +99	0.0
	Lock/unlock shallow alarm setting.	ON, OFF	OFF
	Set depth response. The lower the setting the faster the response to change in depth.	0 - 12	3
	Select speed unit.	KT (Knot), MPH (Miles/Hour), KMH (Kilometers/Hour)	KT
	Select speed resolution. Select number of places to show after decimal point.	0.01, 0.1	0.01
	Set speed adjustment.	0.3 - 2.5	1.0
	Select log unit.	NM (Nautical Mile), SM (Statute Mile), KM (Kilometer)	NM

Setup1 menu items

Display	Function	Setting range or options	Default setting
<div style="border: 1px solid black; padding: 5px; width: fit-content;">           SPD RES CAL   <b>0</b> </div>	Set speed response. The lower the setting the faster the response to change in speed.	0 - 12	0
<div style="border: 1px solid black; padding: 5px; width: fit-content;">           SOG RES CAL   <b>0</b> </div>	Set SOG response. The lower the setting the faster the response to change in speed over ground.	0 - 12	0
<div style="border: 1px solid black; padding: 5px; width: fit-content;">           VMG RES CAL   <b>3</b> </div>	Set VMG response. The lower the setting the faster the response to change in velocity made good.	0 - 12	3
<div style="border: 1px solid black; padding: 5px; width: fit-content;">           *TIMER CAL   <b>On</b> </div>	Enable/disable the timer alarm's audio alarm.	ON, OFF	ON
<div style="border: 1px solid black; padding: 5px; width: fit-content;">           WIND CAL   <b>F</b> </div>	Select source of wind data. Select "r" for second unit.	F: For FI-5001, r: repeater	F
<div style="border: 1px solid black; padding: 5px; width: fit-content;">           WIND KT CAL   </div>	Select wind unit.	KT (Knot), M/S (Meters/Second)	KT
<div style="border: 1px solid black; padding: 5px; width: fit-content;">           WINDADJ CAL   <b>1.0</b> </div>	Set wind speed adjustment.	0.3 - 2.5	1.0
<div style="border: 1px solid black; padding: 5px; width: fit-content;">           ANGLE S CAL   <b>0</b> </div>	Set wind angle offset.	S 0° - 180° P 1° - 179°	0
<div style="border: 1px solid black; padding: 5px; width: fit-content;">           WSPDRES CAL   <b>3</b> </div>	Set wind speed response. The higher the setting the faster the response to change in wind speed.	0 - 12	3

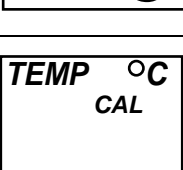
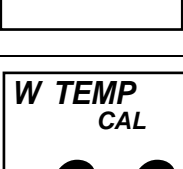
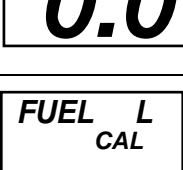

Setup1 menu items

Display	Function	Setting range or options	Default setting
	Select true or magnetic bearing.	MAG (Magnetic), TRU (True)	MAG
	Select heading type to display when activating locked heading.	LOC (Locked), CUr (Current)	LOC
	Set heading response. The lower the setting the faster the response to change in heading.	0 - 12	0
	Select time format.	12, 24 (hour)	12
	Use local time. Enter time difference between local time and GMT to use local time.	-12 - +12	0
	Select water temperature unit.	°C, °F	°C
	Set water temperature offset.	-99 - +99	0
	Select fuel unit.	L (Liter), G (Gallon)	L

### 3.4.2 Setup2 menu





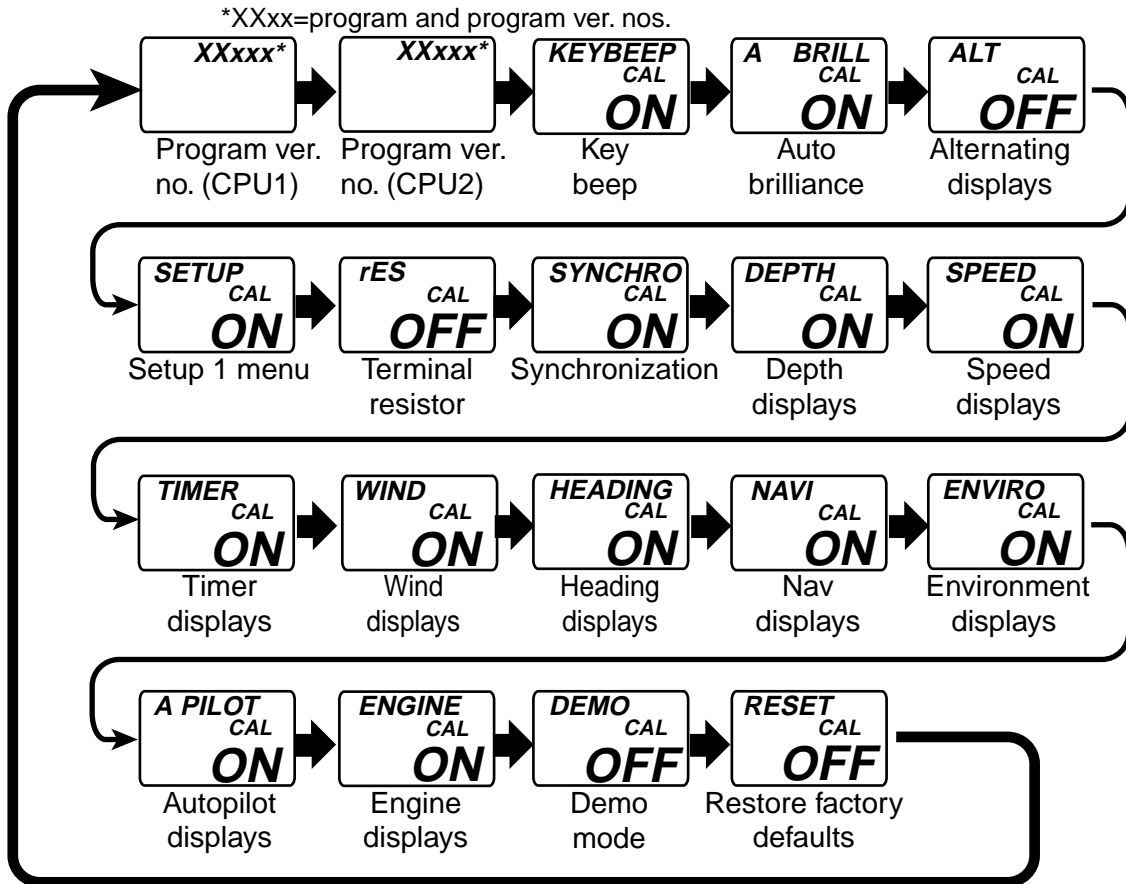

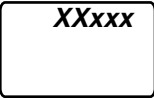
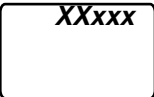

The setup 2 menu contains user settings which once preset do not require frequent adjustment.

1. Press and hold down the **APP/TRUE** and **SELECT/CLEAR** keys together (about 5-6 seconds) to enable the user settings menu. The software version of CPU1 appears. (See the illustration below.)
2. Press the **DISP** key to choose menu item. Each press of the key changes the menu item in the sequence shown below.











3. Use the **SELECT/CLEAR** key to select setting.
4. To continue, press the **DISP** key to select another item.
5. To save settings and restore normal operation, press the **APP/TRUE** and **SELECT/CLEAR** keys together.

Setup2 menu items

Display	Function	Setting range or options	Default setting
	Software version of CPU1. XX=program no. and xxx=program version no.	-	-
	Software version of CPU2. XX=program no. and xxx=program version no.	-	-
	Turn key beep on/off.	ON, OFF	ON
	Auto brilliance on/off.	ON, OFF	ON
	Enable/disable alternating displays.	OFF 1: Depth/boat spd 2: Boat spd/water temp. 3: Depth/water temp. 4: Depth/boat spd/water temp. 5: Roll/pitch 6: Latitude/Longitude	OFF
	Enable/disable access to the setup1 menu.	ON, OFF	ON
	Turn the terminal resistor on/off.	ON, OFF	OFF
	Turn on/off synchronization of FI-50 series instruments.	ON: Synchronize all FI-50 instruments having this setting. OFF: Turn off synchronization. A: Synchronize FI-50 instruments having this setting. b: Synchronize FI-50 instruments having this setting.	ON
	Turn depth displays on/off.	ON, OFF	ON
	Turn speed displays on/off.	ON, OFF	ON

Setup2 menu items

Display	Function	Setting range or options	Default setting
	Turn timer displays on/off.	ON, OFF	ON
	Turn wind displays on/off.	ON, OFF	ON
	Turn heading displays on/off.	ON, OFF	ON
	Turn navigation displays on/off.	ON, OFF	ON
	Turn environmental displays on/off.	ON, OFF	ON
	Turn autopilot displays on/off.	ON, OFF	ON
	Turn engine displays on/off.	ON, OFF	ON
	Demo mode. To enable, press the <b>SELECT/CLEAR</b> key. Depth is shown. To disable and return to this menu, press and hold down the <b>SELECT/CLEAR</b> key.	ON, OFF	OFF
	Restore factory defaults. To restore factory defaults, press and hold down the <b>SELECT/CLEAR</b> key to show ON. Press the key again. A beep sounds upon completion.		

## SPECIFICATIONS OF FI-504 MULTI

### 1 GENERAL

- |     |                 |   |
|-----|-----------------|---|
| 1.1 | Display         | Segment LCD   |
| 1.2 | Display Content | Depth, speed, wind speed, wind angle, timer, environmental information (water temperature, air temperature, air pressure, dewpoint, wind chill temperature), rudder angle |
| 1.3 | I/O Port        | NMEA 2000, 2 ports  |

### 2 JUNCTION BOX (OPTION)

- |     |                    |         |
|-----|--------------------|---------|
| 2.1 | No. of I/O ports   |         |
|     | NMEA 2000 Device   | 6 ports |
|     | NMEA 2000 Backbone | 2 ports |

### 3 POWER SUPPLY AND POWER CONSUMPTION

- |     |              |  |
|-----|--------------|--|
| 3.1 | Display Unit | 12 VDC, less than 0.1 A                    |
| 3.2 | Junction Box | 12 VDC, less than 1 A, max. 2A connectable |

### 4 ENVIRONMENTAL CONDITIONS

- |     |                           |  |
|-----|---------------------------|--|
| 4.1 | Useable Temperature Range | -15°C - +55°C  |
| 4.2 | Relative Humidity         | Less than 95% (+40°C)  |
| 4.3 | Waterproofing             |  |
|     | Display Unit              | IP56   |
|     | Junction Box              | IPX0   |
| 4.4 | Vibration                 | - 2 Hz-5 Hz and up to 13.2 Hz with an excursion of $\pm 1$ mm $\pm 10\%$ ( $7 \text{ m/s}^2$ maximum acceleration at 13.2 Hz);<br>- above 13.2 Hz and up to 100 Hz with a constant maximum acceleration of $7 \text{ m/s}^2$ |





### 5 COATING COLOR

- |     |              |      |
|-----|--------------|------|
| 5.1 | Display Unit | N2.5 |
| 5.2 | Junction Box | N2.5 |

# PACKING LIST FI-504

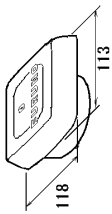
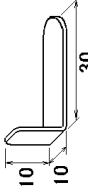
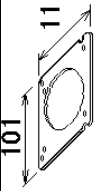
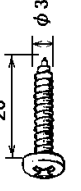
26AA-X-9860 -1



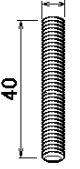

1/1

NAME	UNIT	OUTLINE	DESCRIPTION/CODE	Q'TY
<b>ユニット</b>				
表示部	MONITOR UNIT		FI-504 000-011-745-00	1
<b>工事材料</b> CP26-00600				
INSTALLATION MATERIALS				
パネルリムーバ	PANEL REMOVER		19-028-3124-1 100-340-471-10	1
サフエイクアントスポンジ	SPONGE		TZ7583002A0 000-167-832-10	1
セルフタッピングネジ	SELF-TAPPING SCREW		3X20 SUS304 000-163-884-10	4
バネ座金	SPRING WASHER		M3 SUS304 000-167-404-10	2
ミガキ丸平座金	FLAT WASHER		M3 SUS304 000-167-453-10	2
蝶ナット	WING NUT		M3 SUS304 000-167-826-10	2
寸切ボルト	BOLT		M3X40 SUS304 000-167-804-10	2

コード番号末尾の[\*]\*\*は、選択品の代表コードを表します。

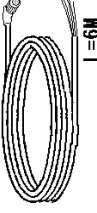
CODE NUMBER ENDING WITH "\*\*\*\*\*" INDICATES THE CODE NUMBER OF REPRESENTATIVE MATERIAL.

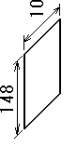
(略図の寸法は、参考値です。DIMENSIONS IN DRAWING FOR REFERENCE ONLY.)

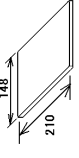

NAME	OUTLINE	DESCRIPTION/CODE	Q'TY
ケーブル組品		FI-50-DROP 000-166-945-10	1
ケーブル組品0.3M		FI-50-CHAIN-0.3M 000-166-949-10	1
<b>図書</b> DOCUMENT			
内部終端/設定		C72-00705-*	1
INTERNAL RESISTOR SETTING		000-168-501-1*	1
操作要領書		OS*-72690-*	1
OPERATOR'S GUIDE		000-167-295-1*	1
取扱説明書		OM*-72690-*	1
OPERATOR'S MANUAL		000-167-332-1*	1

型式/コード番号が2段の場合、下段より上段に代わる通渡期品であり、どちらが入っています。なお、品質は変わりません。

TWO TYPES AND CODES MAY BE LISTED FOR AN ITEM. THE LOWER PRODUCT MAY BE SHIPPED IN PLACE OF THE UPPER PRODUCT. QUALITY IS THE SAME.

**FURUNO**

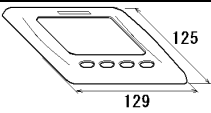
CODE NO.	000-010-619-00	26AA-X-9401 -3
TYPE	FI-50-FLUSH-KIT	1/1

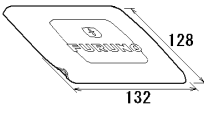
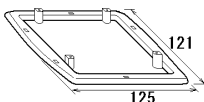
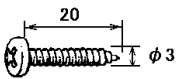
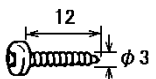
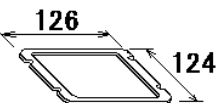
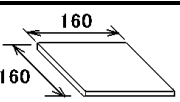
フラッシュマウントキット FLUSH MOUNT KIT.		INSTRUMENTS FI-50			
番号 NO.	名称 NAME	略図 OUTLINE	型名/規格 DESCRIPTIONS	数量 Q'TY	用途/備考 REMARKS
1	前面パネル FRONT PANEL		TZ7580002A0 CODE NO. 000-167-885-10	1	1
2	FURUNO H3 FURUNO STICKER H3		19-028-1502-0 CODE NO. 100-339-580-10	1	1に貼付済み PRE-ATTACHED TO 1.
3	ハードカバー COVER		TZ7580007A0 CODE NO. 000-167-887-10	1	
4	フラッシュマウントツール FRAME		TZ7580008A0 CODE NO. 000-167-886-10	1	
5	セルフタッピングネジ SELF-TAPPING SCREW		3X20 SUS304 CODE NO. 000-163-884-10	4	
6	セルフタッピングネジ SCREW		3X12 SUS304 CODE NO. 000-167-827-10	4	
7	フラッシュマウントスポンジ SPONGE		TZ7583001A0 CODE NO. 000-167-833-10	1	
8	取付要領書 INSTALLATION PROCEDURE		C72-00703-* 7/11 CODE NO. 000-167-323-1*	1	

型式/コード番号が2段の場合、下段より上段に代わる過渡期品であり、どちらかが入っています。なお、品質は変わりません。

TWO TYPES AND CODES MAY BE LISTED FOR AN ITEM. THE LOWER PRODUCT MAY BE SHIPPED IN PLACE OF THE UPPER PRODUCT. QUALITY IS THE SAME.

(略図の寸法は、参考値です。DIMENSIONS IN DRAWING FOR REFERENCE ONLY.)

表1 TABLE 1

寸法区分 (mm) DIMENSION	公差 (mm) TOLERANCE
$L \leq 50$	$\pm 1.5$
$50 < L \leq 100$	$\pm 2.5$
$100 < L \leq 500$	$\pm 3$

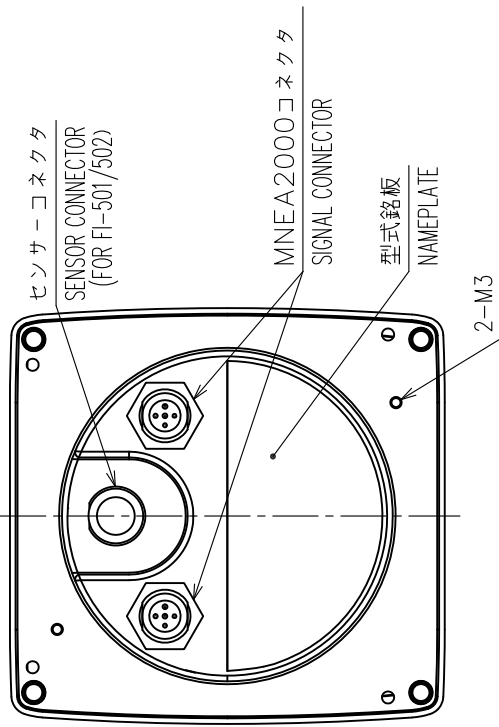
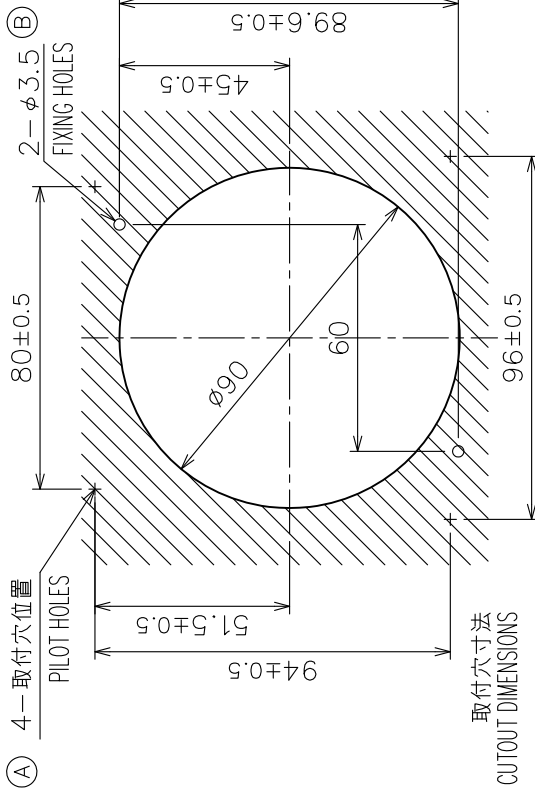
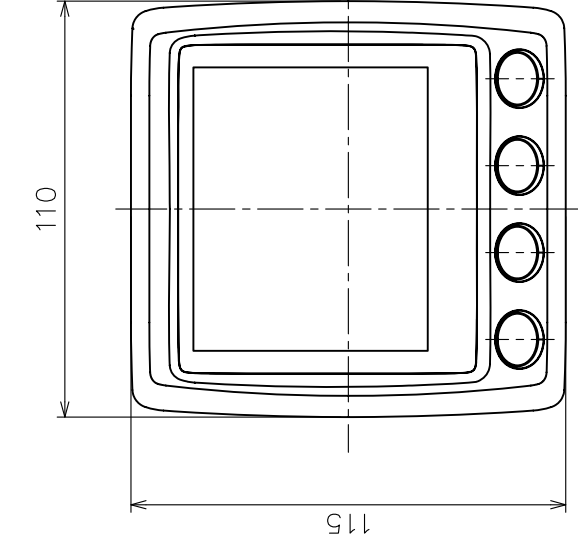
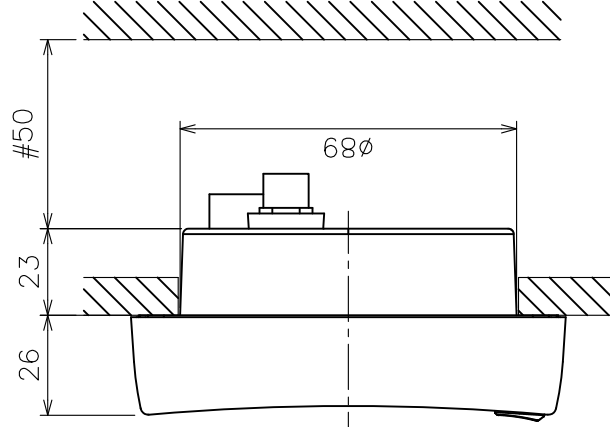
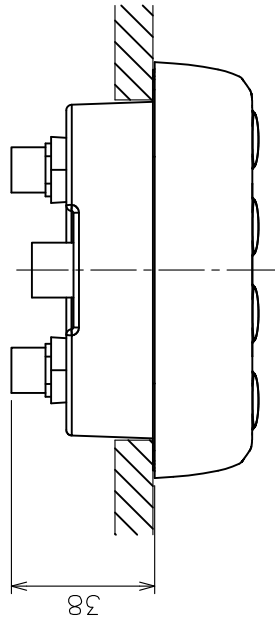

注記

- 1) 指定外の寸法公差は表1による。
- 2) #印寸法は最小サービス空間とする。
- 3) 取付方法は次の2種類から選択する。
  - Ⓐ: ナベタッピンネジ呼び径3×20を使用のこと。
  - Ⓑ: M3×40寸切りボルト、M3平座金/バネ座金/蝶ナットを使用のこと。

NOTE

1. TABLE 1 INDICATES TOLERANCE OF DIMENSIONS.
2. # MINIMUM SERVICE CLEARANCE.
3. SELECT FIXING METHOD FROM FOLLOWINGS;
  - Ⓐ : USE TAPPING SCREWS  $\phi 3 \times 20$ .
  - Ⓑ : USE M3 STUD BOLT, P.W. / S.W. / WING NUT, SCREW LENGTH: 40.

DRAWN	Jul. 19 '07	T. YAMASAKI	TITLE	FI-501/502/503/504/505/506
CHECKED	Jul. 19 '07	I. TAKENO	名称	インストルメント (サーフェスマウント)
APPROVED	Jul. 24 '07	R. ESUMI	外寸図	
SCALE	1/100	MASS 0.29 kg	NAME	INSTRUMENT (SURFACE MOUNT)
DWG.No.	C7266-G02-A	REF.No.	26-001-102G-2	OUTLINE DRAWING





表1 TABLE 1

寸法区分 (mm) DIMENSION	公差 (mm) TOLERANCE
L ≤ 50	±1.5
50 < L ≤ 100	±2.5
100 < L ≤ 500	±3

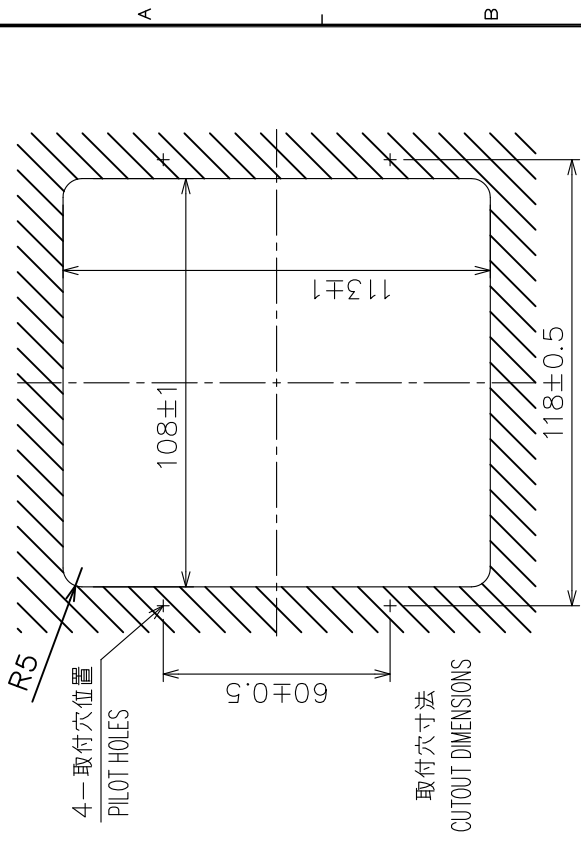
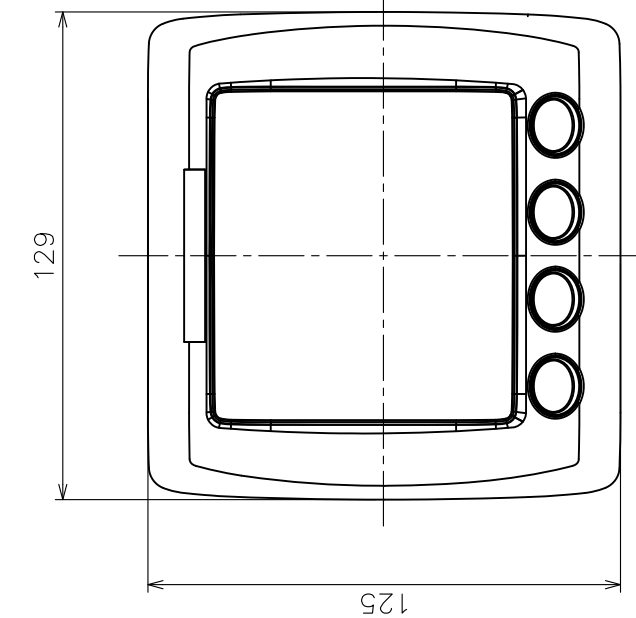
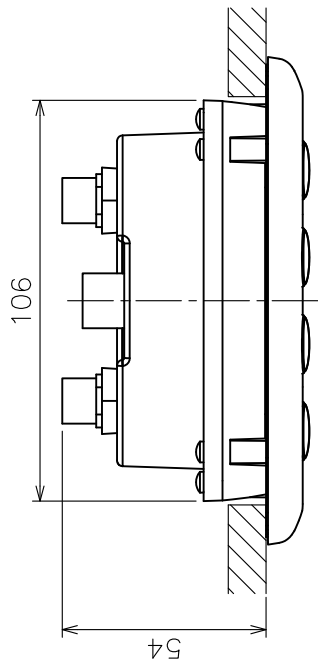
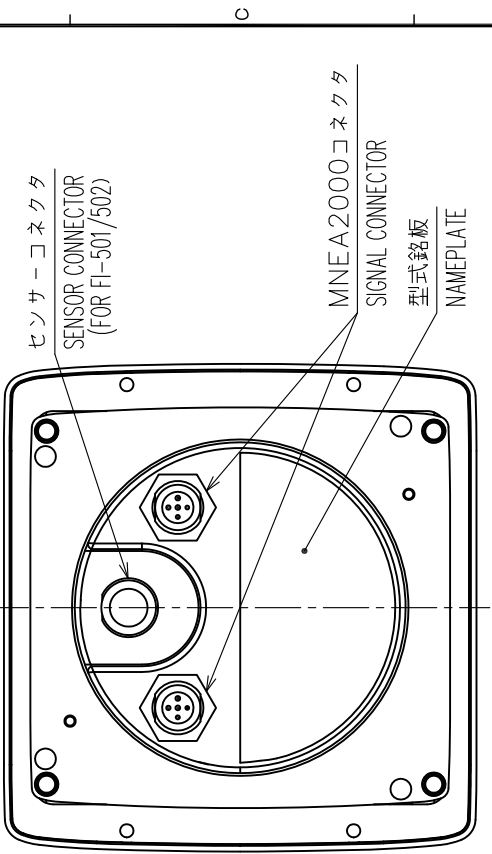
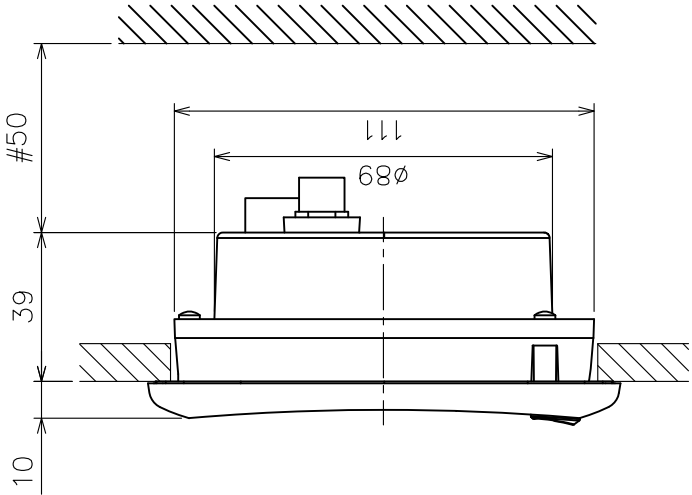

注 記

- 1) 指定外の寸法公差は表1による。
- 2) 取付用ネジはナベタネ呼び径3×20を使用のこと。

NOTE

1. TABLE 1 INDICATES TOLERANCE OF DIMENSIONS WHICH IS NOT SPECIFIED.
2. USE TAPPING SCREWS  $\phi 3 \times 20$  FOR FIXING THE UNIT.

DRAWN	Jul. 19 '07	T. YAMASAKI	TITLE	FI-501/502/503/504/505/506
CHECKED	Jul. 19 '07	I. TAKENO	名称	インストルメント (フラッシュマウント)
APPROVED	Jul. 24 '07	R. Esumi	外寸図	
SCALE		MASS 0.3 kg	NAME	INSTRUMENT (FLUSH MOUNT)
DWG.No.	C7266-G01-A	REF.No.	26-001-101G-0	OUTLINE DRAWING

表1 TABLE 1

寸法区分 (mm) DIMENSION	公差 (mm) TOLERANCE
L ≤ 50	±1.5
50 < L ≤ 100	±2.5
100 < L ≤ 500	±3

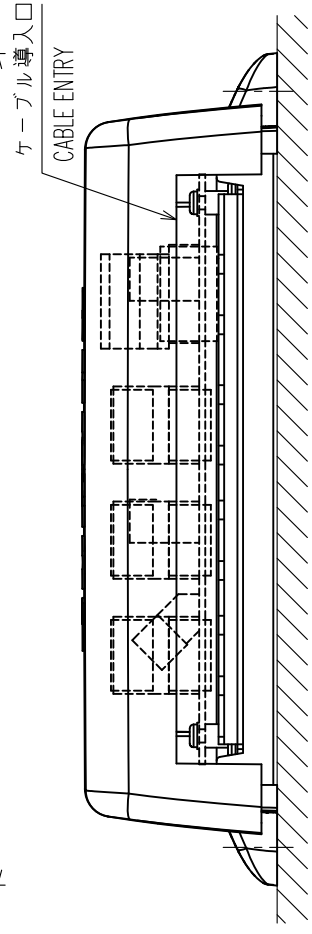
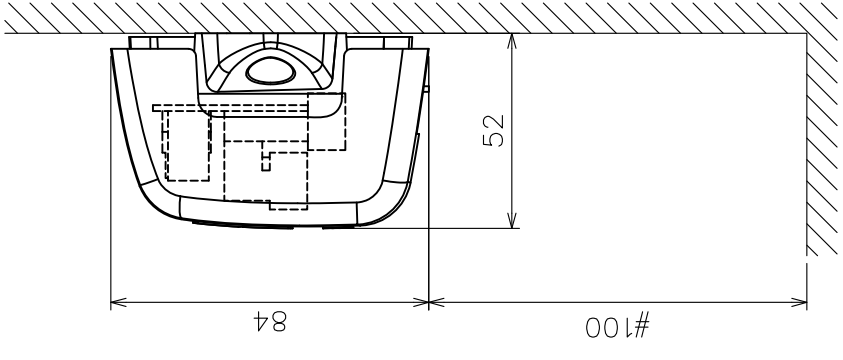
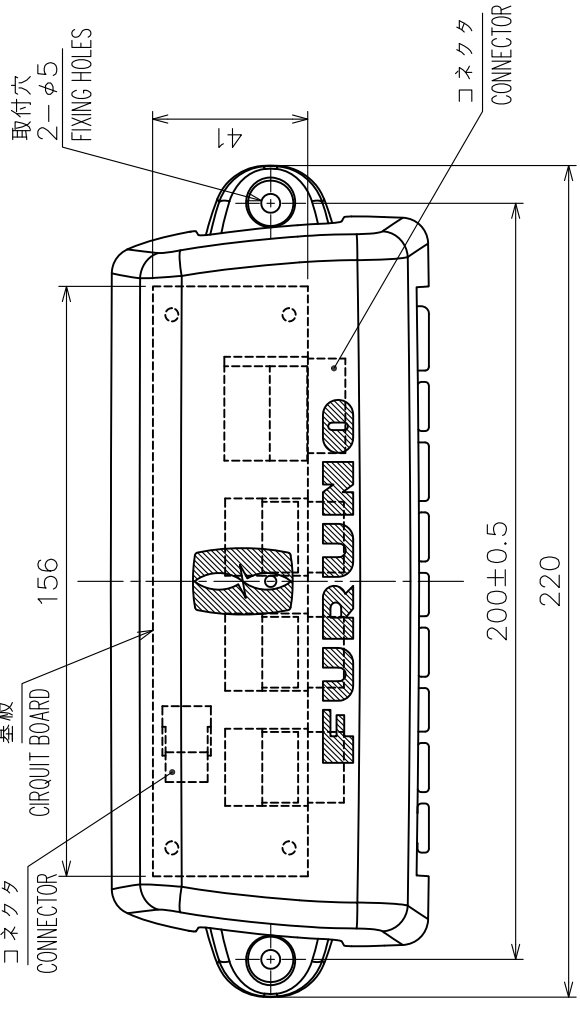

注 記

- 1) #印寸法は最小サービスマン間寸法とする。
- 2) 指定外の寸法公差は表1による。
- 3) 取付用ネジはトラスタップピンネジ呼び径4×20を使用のこと。

NOTE

1. # MINIMUM SERVICE CLEARANCE.
2. TABLE 1 INDICATES TOLERANCE OF DIMENSIONS WHICH IS NOT SPECIFIED.
3. USE TAPPING SCREWS  $\phi 4 \times 20$  FOR FIXING THE UNIT.

DRAWN	Jul. 19 '07	T. YAMASAKI	TITLE	FI-5002
CHECKED	Jul. 19 '07	I. TAKENO	名称	ジャンクションボックス
APPROVED	Jul. 24 '07	R. Esumi	外寸図	
SCALE	1/100	0.3 kg	NAME	JUNCTION BOX
DWG.No.	C7268-G01-A	REF.No.	26-001-103G-0	OUTLINE DRAWING

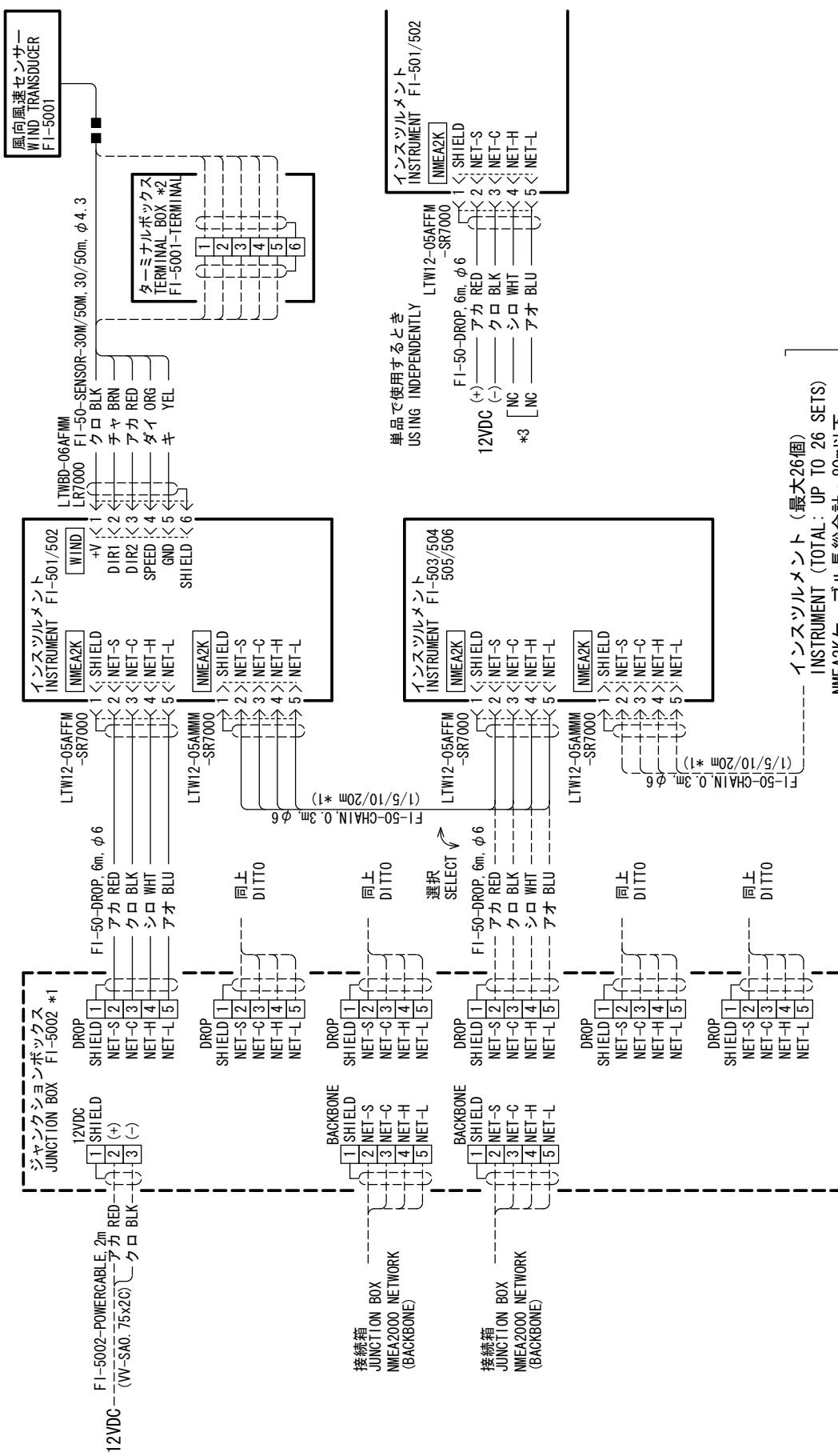

注記 \* 1) オプション。  
 \* 2) ケーブルを切断する場合は、ターミナルボックス（非防水）を使用のこと。  
 \* 3) 短絡しないように、端末を処理する。

インストルメント (最大26個)  
 INSTRUMENT (TOTAL: UP TO 26 SETS)  
 NMEA2Kケーブル長総合計: 80m以下  
 NMEA2K CABLE TOTAL LENGTH: UP TO 80m

単品で使用するとき  
 USING INDEPENDENTLY

インストルメント  
 INSTRUMENT FI-501/502

NMEA2K

LTW12-05AFFM -SR7000

FI-50-DROP 6m, φ6

12VDC (+) アカ RED 1 < SHIELD  
 (-) クロ BLK 2 < NET-S  
 [NC シロ WHT 3 < NET-C  
 \*3 アオ BLU 4 < NET-H  
 5 < NET-L

注記 \* 1) オプション。  
 \* 2) ケーブルを切断する場合は、ターミナルボックス（非防水）を使用のこと。  
 \* 3) 短絡しないように、端末を処理する。

DRAWN	Oct. 9 '07	T. YAMASAKI	TITLE	FI-501/502/503/504/505/506
CHECKED	Oct. 9 '07	T. TAKENO	名称	インストルメント
APPROVED	Oct. 10 '07	R. Esumi	相互結線図	
SCALE		MASS	INSTRUMENT	
DWG. No.	C7266-C01-D	REF. No.	INTERCONNECTION DIAGRAM	

